



Rapid Heating / Cooling Oven

Model:DKG610(V)/650(V)

Model:DKG810(V)/850(V)

Instruction Manual

Second Version

- Thank you very much for purchasing this Yamato DKG Series.
- Please read the “Operating Instructions” and “Warranty” before operating this unit to assure proper operation. After reading these documents, be sure to store them securely together with the “Warranty” at a handy place for future reference.

Warning:

Before operating the unit, be sure to read carefully and fully understand important warnings in the operating instructions.

Yamato Scientific Co., Ltd.

1. Safety precautions	1
Explanation of pictograms	1
List of symbols	2
Warning · Cautions	3
2. Before operating the unit	4
Precautions when installing the unit	4
Installation procedures/precautions	9
3. Names and Functions of Parts	10
Main unit	10
Structural diagram	12
Operation panel	13
Description of characters	14
4. Operating Procedures	16
List of operation modes and functional menus	16
Operation mode and function setting keys and characters	18
Setting of the overheat preventive device	19
Operation steps (Fixed temp operation)	20
Operation steps (Quick Auto Stop operation)	21
Operation steps (Auto Stop operation)	22
Operational steps (Auto Start operation)	24
Creating a program	26
Program repeat operation	31
Program sheet	32
Useful functions (calibration offset function)	34
Useful function (Lock function)	35
Useful function (External alarm output)	36
Useful functions (Output terminal)	37
Option (Overheat preventive unit)	39
Option (RS485 communication function)	40
5. Handling Precautions	52
6. Maintenance procedures	54
Daily inspection/maintenance	54
7. When the unit is not to be used for a long time or when disposing	55
When the unit is not to be used for a long time or when disposing	55
Notes about disposition	55
8. Troubleshooting	56
Safety device and error codes	56
When a malfunction is suspected	57
9. After sales service and warranty	58
When requesting a repair	58
10. Specifications	59
11. Wiring diagram	61
12. Replacement parts list	63
13. List of dangerous materials	65
14. Standard installation manual	66

1. Safety precautions

Explanation of pictograms

About pictograms

A variety of pictograms are indicated in this operating instruction and on products for safe operation. Possible results from improper operation ignoring them are as follows.

Be sure to fully understand the descriptions below before proceeding to the text.

 **Warning** Indicates a situation which may result in death or serious injury (Note 1.)

 **Caution** Indicates a situation which may result in minor injury (Note 2) and property damages (Note 3.)

(Note 1) Serious injury means a wound, an electrical shock, a bone fracture or intoxication that may leave after effects or require hospitalization or outpatient visits for a long time.

(Note 2) Minor injury means a wound or an electrical shock that does not require hospitalization or outpatient visits for a long time.

(Note 3) Property damage means damage to facilities, devices and buildings or other properties.

Meanings of pictograms

 This pictogram indicates a matter that encourages the user to adhere to warning ("caution" included).
Specific description of warning is indicated near this pictogram.

 This pictogram indicates prohibitions
Specific prohibition is indicated near this pictogram.

 This pictogram indicates matters that the user must perform
Specific instruction is indicated near this pictogram.

1. Safety precautions

List of symbols

Warning



General warnings



Danger!: High voltage



Danger!: High temperature



Danger!: Moving part

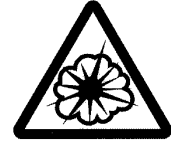

Danger!: Hazard of explosion

Caution



General cautions



Electrical shock!



Burning!



Caution for no liquid heating!



Caution for water leak!



For water only



Poisonous material

Prohibitions



General bans



Fire ban



Do not disassemble



Do not touch

Compulsions



General compulsions



Connect ground wire



Install levelly



Pull out the power plug



Regular inspection

1. Safety precautions

Warning · Cautions

Warning



Never operate the unit in an atmosphere containing flammable or explosive gas

Never operate the unit in an atmosphere containing flammable or explosive gas. Otherwise, an explosion or a fire may result since the unit is not explosion-proof. See section "13. List of dangerous materials" on page65.



Be sure to connect the ground wire.

Be sure to connect the ground wire correctly. Otherwise, electrical leak may result and cause an electrical shock or a fire.



Ban on operation when an abnormality occurs

When a smoke or an unusual odor is seen or sensed, immediately turn the ELB on the main unit off and pull out the power plug. A fire or an electrical shock may result.



Never use electrical power cords bundled.

When these are used bundled, they might overheat causing a fire.



Take care not to damage electrical power cords.

Avoid tightly bend, pull with a strong force or twist to prevent electrical power cords from damaging. A fire or an electrical shock may result.



Never use an explosive or a flammable material with this unit.

Never use an explosive material, a flammable material or a material containing them. An explosion or an electrical shock may result. See section "13. List of dangerous materials" on page 65.



Never try to touch a hot part.

Some parts of the unit are hot during and immediately after operation. Take special care for possible burning.



Never try to disassemble or alter the unit.

Never try to disassemble or alter the unit. A malfunction, a fire or an electrical shock may result.



Caution



When a thunder is heard.

When a thunder is heard, turn the main power off immediately. A malfunction, fire or an electrical shock may result.

2. Before operating the unit

Precautions when installing the unit

1. Carefully select an installation site.



Take special care not to install the unit at a place described below:

- Uneven surfaces or dirty surfaces
- Where flammable gas or corrosive gas exists
- Where the ambient temperature is 35°C or more
- Where temperature changes severely
- Where dusty and humidity is high
- Where subject to direct sunlight
- Where vibration is severe



Install this unit at a place with spaces shown below.

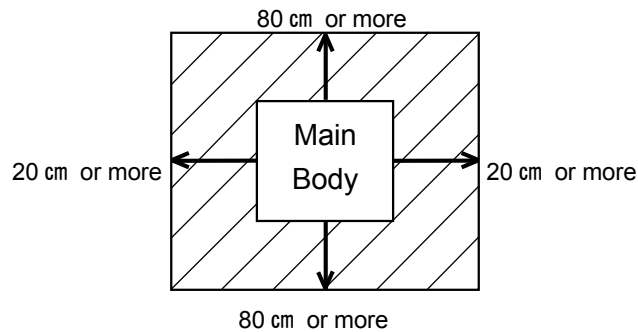

2. Install the unit on a level surface.



Install the unit on a level surface. If the whole bottom surface of the unit does not contact the surface evenly, vibrations or noises may result. This might cause unexpected troubles or malfunctions.

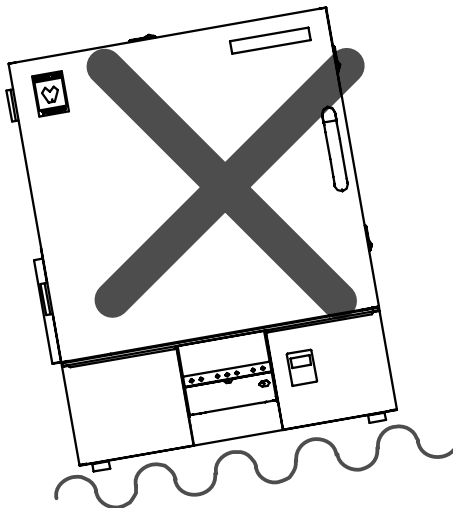

The unit weight: DKG610(V)/650(V): Approx. 110 kg, DKG810(V)/850(V): Approx. 155 kg
When lifting the unit for transportation and installation, carefully handle it by at least two people.

3. Installation



The unit might fall down or move by an earthquake or an impact resulting a personal injury.
We recommend making safety measures such as to avoid installing the unit at a place other than busy places.

2. Before operating the unit

Precautions when installing the unit

4. Secure sufficient ventilation for the unit.



Do not operate the unit when suction port and heat radiation port on the side and rear panels are blocked.

Internal temperature of the unit will rise degrading the performance and an accident, a malfunction or a fire may result.

5. Do not operate the unit at such a place that may subject to splash.



Do not operate the unit at such a place that may subject to splash. Liquid entering the inside may cause an accident, a malfunction, an electrical shock or a fire.

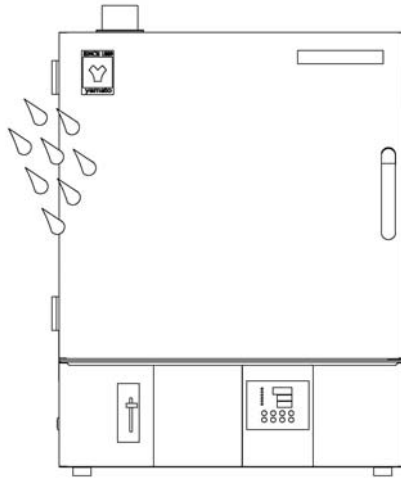

6. Never operate the unit in an atmosphere containing flammable or explosive gas.



Never operate the unit in an atmosphere containing flammable or explosive gas. Since the unit is not explosion-proof, an arc is discharged when switching the ELB “ON(I)” and “OFF(O)” and during operation and a fire or an explosion may result.



See the section “13. List of dangerous materials” on page 65 for flammable and explosive gases.

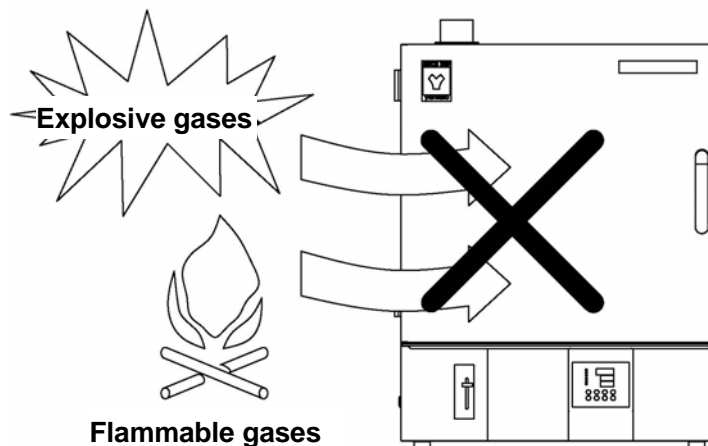

2. Before operating the unit

Precautions when installing the unit

7. Be sure to connect the power plug to the dedicated power distribution panel or a wall outlet.



Use a power distribution panel or a wall outlet that meets the electrical capacity of the unit.

Electrical capacity:	DKG610 (V)	AC200V-220V	$13.3 \pm 10\% \sim 14.6 \pm 10\% \text{ A}$
	DKG650 (V)	AC230V-240V	$11.6 \pm 10\% \sim 12.1 \pm 10\% \text{ A}$
	DKG810 (V)	AC200V-220V	$18.5 \pm 10\% \sim 20.3 \pm 10\% \text{ A}$
	DKG850 (V)	AC230V-240V	$16.2 \pm 10\% \sim 16.8 \pm 10\% \text{ A}$

- * When the unit will not start even when you turn the Electric Leakage Breaker to "ON(I)", check for low main voltage or if the unit is connected to the same power supply line as other devices and connect it to another line if necessary.

Avoid connecting too many devices using a branching outlet or extending a wire with a cord reel or heating function and temperature controlling function may degrade due to voltage drop.



Do not connect the unit to any parts or lines other than a correct power supply line such as a gas pipe, a water pipe or a telephone line. Otherwise, an accident or a malfunction may result.

8. Handling of a power cord



Never use electrical power cords bundled. When these are used bundled, they might overheat causing a fire.

Do not convert, forcibly bend, twist or pull the power cord. Otherwise, a fire or an electrical shock may result.

Do not place the power cord under a desk or a chair, or sand between objects to avoid it from being damaged.

Otherwise, a fire or an electrical shock may result.

Do not place the power cord close to a stove or other heat generating device. Sheath of the cord may burn and result in a fire or an electrical shock.



If the power cord should be damaged (exposure of core wire or disconnection), immediately turn the ELB off (O), turn the power supply off and ask your dealer to replace the cord. If the unit is operated with a damaged power cord, a fire or an electrical shock may result.



Connect the power cord to an appropriate wall outlet or distribution board.

9. Be sure to connect the ground wire.



- When the unit has no ground terminal, class D grounding work is necessary and please consult your dealer or our nearest sales office.
- Securely connect to an outlet.

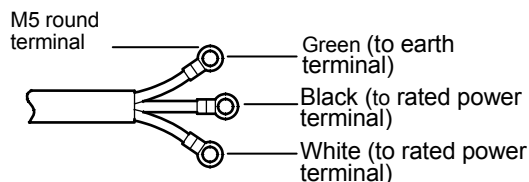

The unit does not have a power plug. Connect the earth correctly to suit the power facility to be connected.



Do not connect the grounding wire to any parts or lines other than a correct grounding terminal such as a gas pipe, a water pipe or a telephone line. Otherwise, an accident or a malfunction may result.

2. Before operating the unit

Precautions when installing the unit

10. Be careful for the colors of core wires when connecting the power cords.



Be sure to first make sure that the breaker on the power facility side is "Off (O)" before connecting the power cords.

The unit does not have a power plug. Select and connect a plug and a terminal with correct ratings suited to the power source capacity of the power facility to be connected. (See the table in the right)

Core wire color	Indoor wiring
Black	Voltage side
White	Earth side
Green	Earth

11. Do not attempt to alter the unit



The customer shall never attempt to alter the unit. Otherwise a malfunction may result.

MODIFICATION

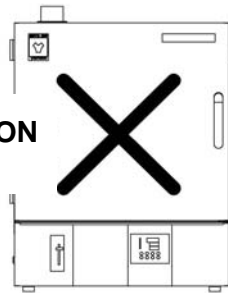

12. Do not put too many specimens.



The withstand load of a shelf board is 15kg when the load is evenly distributed.

Put specimens dispersed.

When shelf boards have been placed on all stages, take care not to exceed the total withstand load.

《Total withstand load》

DKG610(V),DKG650(V) : 45Kg or less

DKG810(V),DKG850(V) : 75Kg or less

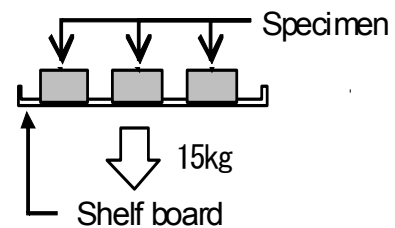

13. Do not set too many specimens.



Too many specimens will prevent correct temperature control. In order to assure temperature precision, be sure to use shelf boards and put specimens dispersed, and secure at least 30% of space inside the bath.

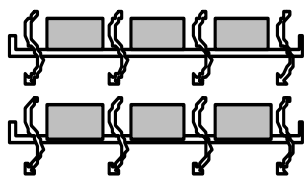

Secure at least 30% of space

14. Do not place an object on the bottom plate.



Operating the unit with placing the specimen directly on the bottom plate of the internal bath will prevent performance of the product from fully exerting, increase the internal temperature excessively and may cause a malfunction.

Never place a specimen on the bottom plate of the internal bath.

See "15. Installing shelf boards and placing specimen" on P8.

2. Before operating the unit

Precautions when installing the unit

15. Placing shelf boards and specimens



Shapes of shelf boards will differ depending on the model and each model contains two or four boards.

One of them has been fixed on the lowest stage of the shelf peg pillars inside the unit with screws at the time of factory shipping.

Set the remaining shelf boards to appropriate positions in the unit.



One of the shelf boards has been fixed on the lowest stage of the shelf peg pillars inside the unit with screws at the time of factory shipping.

A heater and a fan are installed under the rectifier plate. And temperature of the rectifier plate and around it is always higher than the set temperature and if you place a specimen directly on the plate, it may burn or a fire may result.

Slit at the front side of the rectifier plate is the suction slit of the hot air convection route. Never block this slit with a specimen or other objects.

For this reason, the shelf boards are held with screws as shown in the drawing to prevent specimens from being placed directly.

If you need to remove shelf boards due to the shape of a specimen to set, secure sufficient space to the rectifier plate and never place the specimen directly.

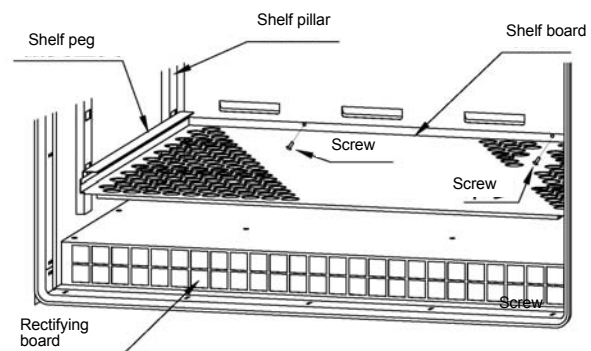

16. About handling of the exhaust port (manual damper)



The exhaust port is located at the rear of the main unit. While the manual damper is used, hot air will be exhaust at the port. So be sure to connect the exhaust duct and assure sufficient space behind the back of the main unit. The exhaust port and around it will become hot and take sufficient care for burning.

Exhaust port flange dia. : $\Phi 80\text{mm}$

Air amount when damper is fully opened (environmental temp. : 23°C , at no load, in-bath temp : 25°C)

DKG610(V), DKG650(V) : $1.5 \text{ m}^3/\text{min}$

DKG810(V), DKG850(V) : $1.4 \text{ m}^3/\text{min}$

About ventilating operation

When you attempt to increase temperature with the manual damper open, note that the target temperature may not be reached depending on the openness of the damper, the environmental temperature, or the amount of specimen.

(Temperature can be raised up to 260°C at environmental temp : 23°C , no-load, and up to 50% of damper openness. Note that the temperature rise time is not guaranteed.)

See "3.Names and functions of parts" on P10 & 11.

Precautions when Installing the Unit

Installation procedures/precautions

- (1) Release the stopper lock of the caster wheels.

Set the stoppers of the caster wheels to the high position as shown in the drawing in the right.

Now the lock is released.

(Only two caster wheels at the front of the unit have stoppers.)

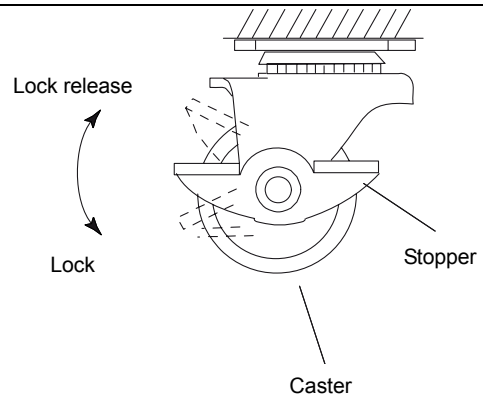

- (2) Transport the unit to the installation site.

* Transporting the unit over a gap may give an excessive shock to the caster wheels and may damage them.

If such trouble is expected, lift the unit and transport it over the gap.

- (3) Lock the caster stoppers when the unit has been transported to the installation site.

They are locked.

- (4) Connection of the power supply.

Make sure that the ELB is "OFF(O)" before connecting the power supply to the power distribution board and the outlet.

※(1),(2),and (3) are for DKG810(V)/DKG850(V) only.

3. Names and Functions of Parts

Main unit

DKG610 (V)/650(V)

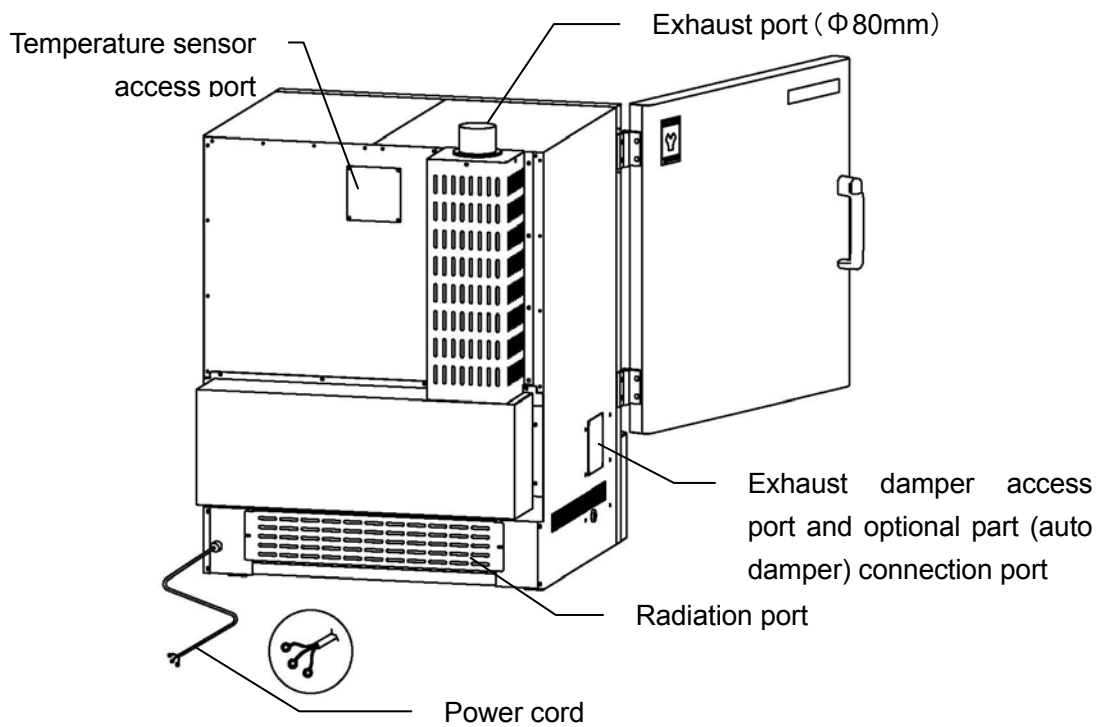
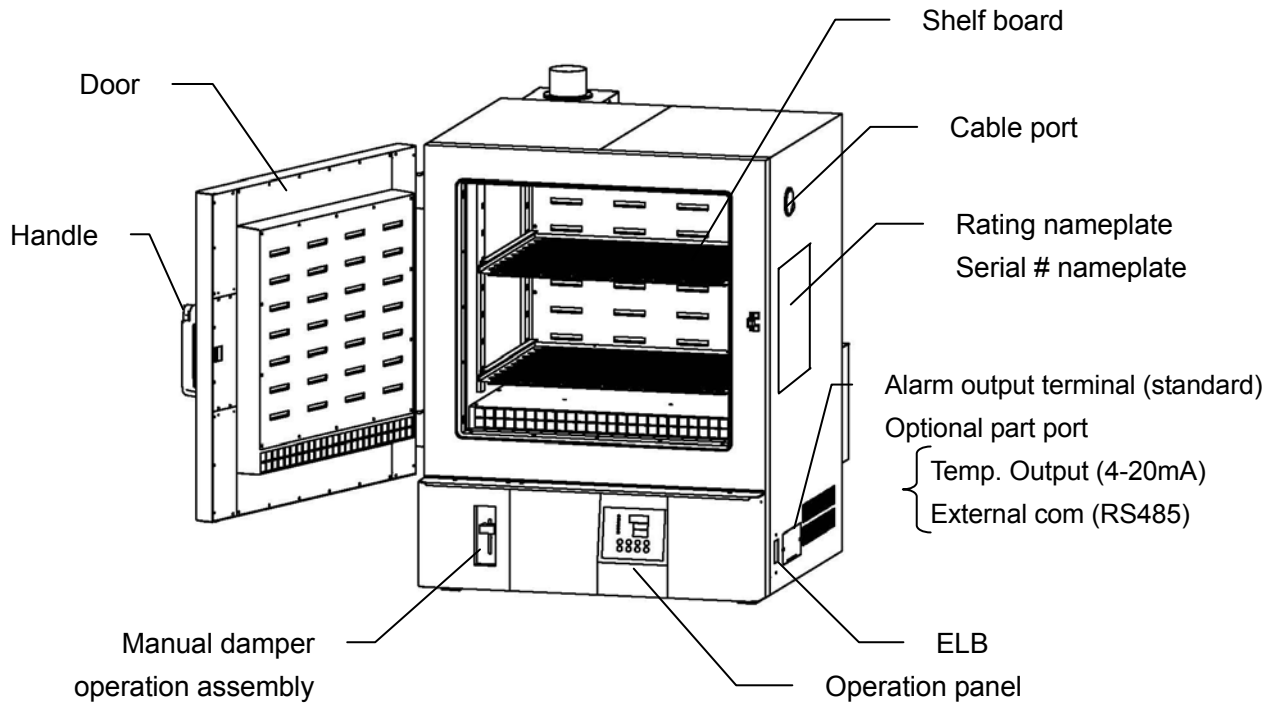

3. Names and Functions of Parts

Main unit

Front of DKG810 (V)/850(V)

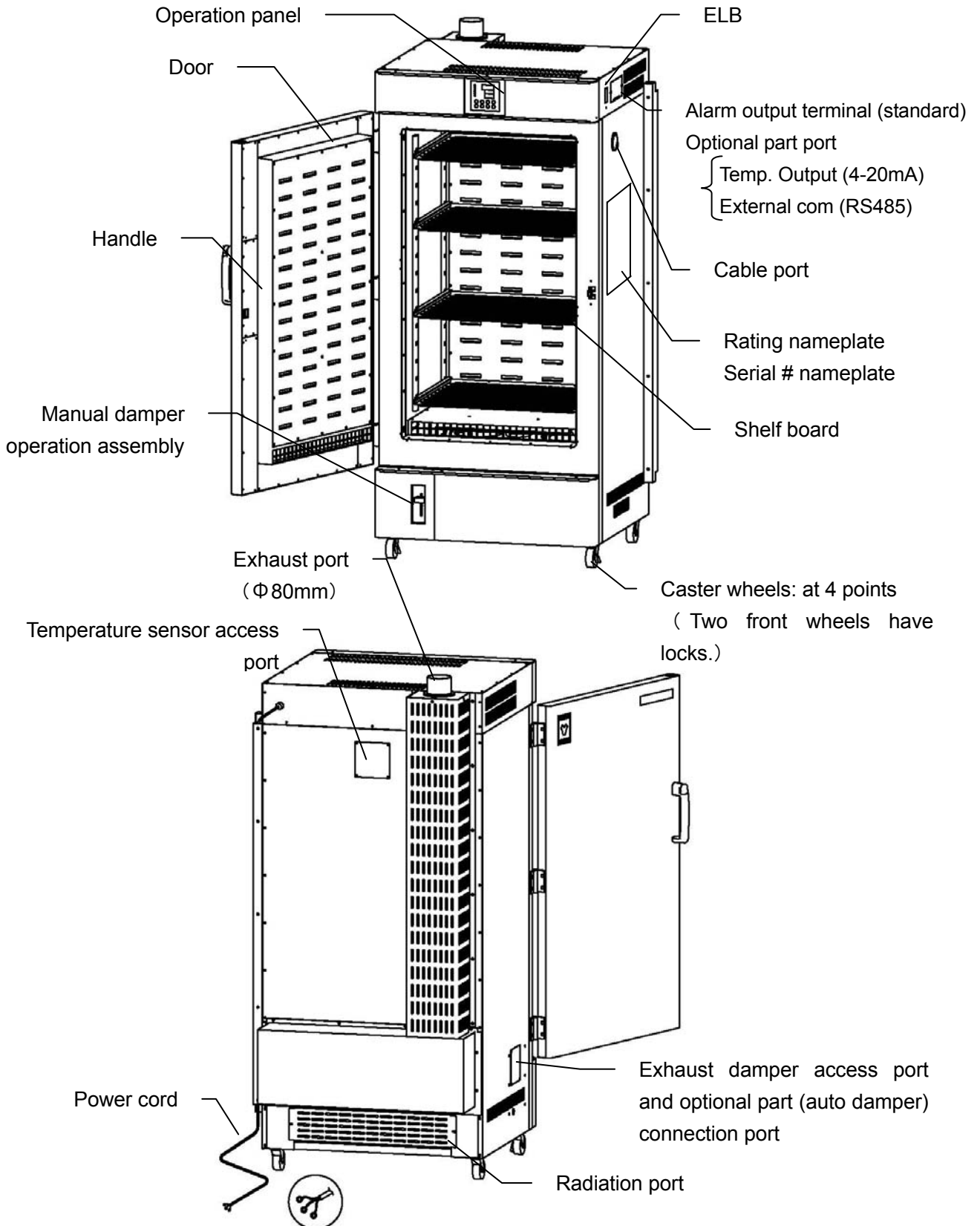

3.Names and Functions of Parts

Structural diagram

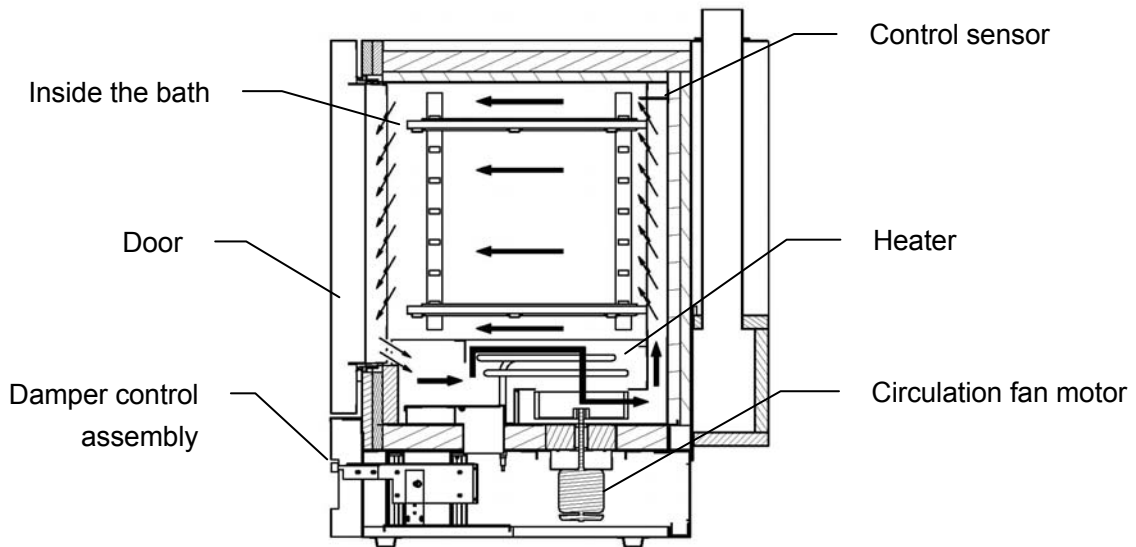

During regular operation (Damper openness: 0%)

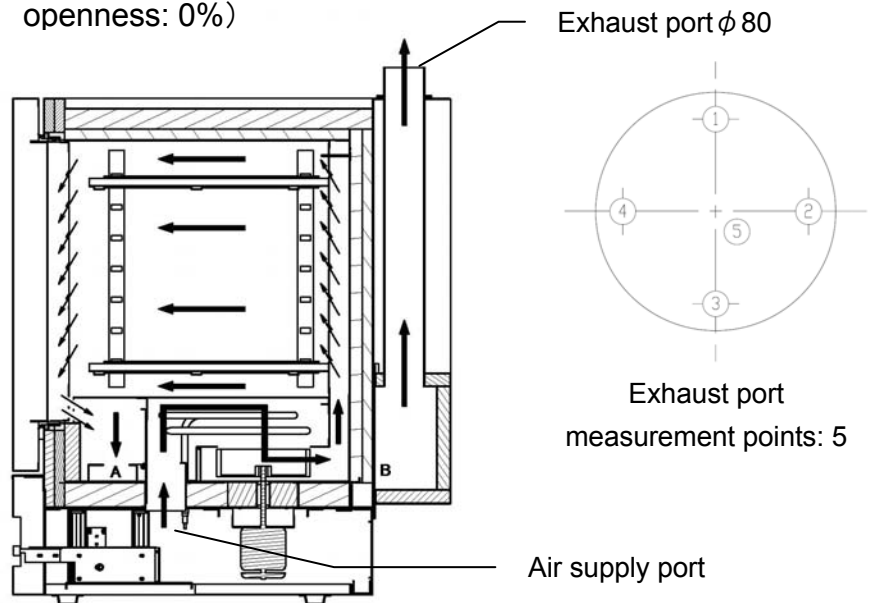

During exhaust operation (Damper openness: 100%)

Exhaust: From A through internal bath side BOX and exhausted at B

Exhaust flow at different damper openness (environmental temp: 23°C, no-load, in-bath temp : 25°C)※

	0% (full close)	25%	50%	75	100%(full open)
600 type	0.0 m ³ /min	0.1 m ³ /min	0.1 m ³ /min	0.3 m ³ /min	1.5 m ³ /min
800 type	0.0 m ³ /min	0.1 m ³ /min	0.1 m ³ /min	0.5 m ³ /min	1.4 m ³ /min

The air supply port and the exhaust port are linked for the supply/exhaust system of this unit. Four openness levels are available: 25%, 50%, 75%, and 100%. At full open, or 100% of openness, total supply/exhaust will be complete external air displacement, which will improve cooling efficiency. When operation is finished and you want to start cooling operation, first press the STOP button and then start damper operation. During displacement operation (damper is opened during operation), the target temperature may not be reached and adjust damper openness according to the specific conditions.

※Average measured value for 5 points on the exhaust port looked from above.

3. Names and Functions of Parts

Operation panel

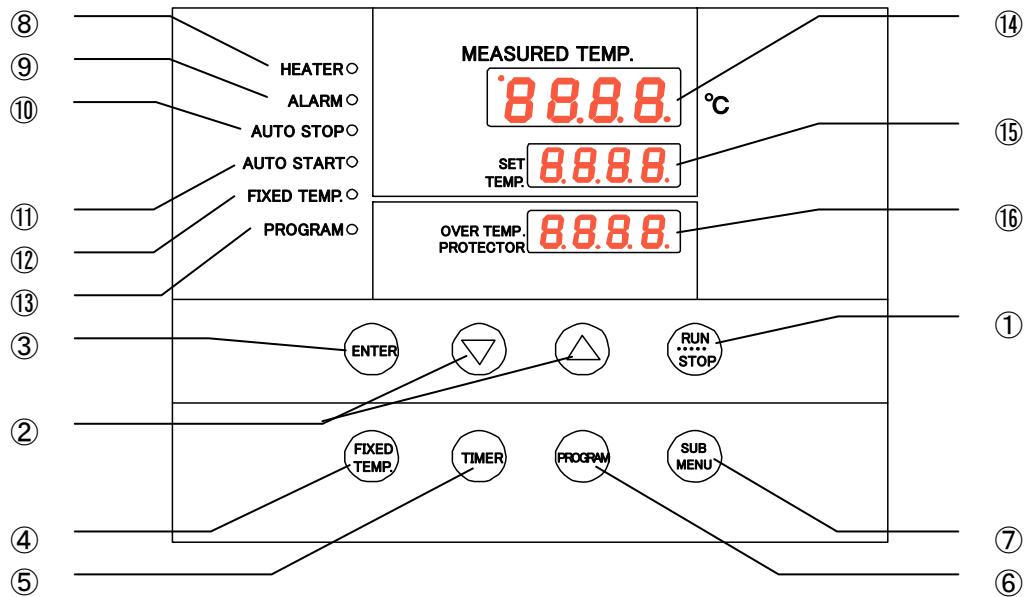













No	Name	Operation/action
①	RUN/STOP Key	This key is used to start/stop operation.
②	▽, △ Key	These keys are used to select a setting.
③	ENTER Key	This key is used to determine a setting you selected.
④	FIXED TEMP. Key	This key is used to select the fixed temperature operation.
⑤	TIMER Key	This key is used to select the timer operation. You can select from quick auto stop operation, auto stop operation, and auto start operation.
⑥	PROGRAM Key	This key is used to make a program and to select program operation. You can set a program from 3 types, 6 patterns.
⑦	SUB MENU Key	This key is used to set overheat preventive device temperature, a temperature for calibration offset, key lock, and the program repeat function.
⑧	HEATER Lamp	This lamp comes on while power is supplied to the heater.
⑨	ALARM Lamp	Buzzer sounds and this lamp come on when an error occurs.
⑩	AUTO STOP Lamp	This lamp flashes during quick auto stop timer setting and stays on during operation. This lamp flashes during auto stop timer setting and stays on during operation.
⑪	AUTO START Lamp	This lamp flashes during auto start time setting and stays on during operation.
⑫	FIXED TEMP. Lamp	This lamp flashes during fixed temp operation setting and stays on during operation.
⑬	PROGRAM Lamp	This lamp flashes during program operation setting and stays on during operation.
⑭	MEASURED TEMP. Display	The display indicates measured in-bath temperature, setting characters, and alarm information.
⑮	SET TEMP. Display	The display indicates a set temperature, timer setting, and timer remaining time.
⑯	OVER TEMP. PROTECTOR Display	The display indicates a set temperature of the overheat preventive device.

3. Names and Functions of Parts



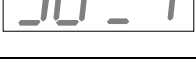

Description of characters

Characters used on the controller of this unit are described here.

Characters	Identifier	Name	Application
	Fix	Fixed Temp operation setting	This means Fixed Temp operation settings.
	Sv	Temperature setting	This is used to set a temperature.
	AStP	Auto Stop setting	This is used to set Auto Stop operation.
	AStr	Auto Start setting	This is used to set Auto Start operation.
	tim	Time setting	Used for setting a time.
	PrG3	Program type selection	This is used to select a program type to use from 1 to 3. See "Creating a program" on P.26.
	PAt	Program selection pattern	This is used to select a program pattern to use. See "Creating a program" on P.26.
	End	Time up	This is displayed when Timer operation is finished. See P.21 and 23.
	Sv-1	Program temperature setting	This is used to set a temperature for each step of a program. (Displayed range is Sv-1~Sv-30)
	t-1	Program time setting	This is used to set a time for each step of a program. (Displayed range is t-1~t-30)
	PS-3	Selection of return destination of program repeat	This is used to select a return destination step for program repeat operation. See "Program Repeat operation" on P.31.
	Pc-2	Setting of program repeat	This is used to set a number of Program Repeat operation. See "Program Repeat operation" on P.31.

3.Names and Functions of Parts

Main body

Character	Identifier	Name	Application
	cAL	Calibration Offset setting	This is used to enter a calibration offset temperature. See “Useful functions (Calibration Offset function)” on P. 34.
	oH	Overheat preventive device temperature setting	This is used to set a temperature of the overheat preventive device. See “Setting the overheat preventive device” on P.19.
	Lock	Setting key lock	Key locks settings to prevent their alterations. See “Useful functions (Lock function)” on P.35.
	door	Door open display	This indication appears when the door is opened. If you open the door during operation, control (heater and fan) will be stopped, and automatically recovers when you close the door.

※ For characters of operation modes and function setting keys, see “Operation modes and function setting keys and characters” on P.18.

4. Operating Procedures

List of operation modes and functional menus

Operation modes of this unit are as follows.

No.	Name	Description	Page
1	Fixed Temp operation	Pressing FIXED TEMP key enters the Fixed Temp operation setting mode. Pressing FIXED TEMP key again enters the Temperature Setting mode. Use ▽ and △ keys to set a temperature. Press RUN/STOP key to start operation and press RUN/STOP key to stop operation.	P.20
2	Quick Auto Stop operation	This function is used when, for example, “to stop operation in the middle of it after several hours”. You can press TIMER key to set a time to stop operation during the Fixed Temp operation. Use ▽ and △ keys to set a time. Pressing RUN/STOP key starts Quick Auto Stop operation and the timer starts in the middle of it and automatically stops operation when after set time elapsed.	P.21
3	Auto Stop operation	This is used to set “operation to automatically stop when setting Fixed Temp operation.” Press TIMER key to display “AStP”. You can press ENTER key to set a set temperature “Sv”. You can set an operation time “tim” by pressing ENTER key again. Pressing RUN/STOP key starts Auto Stop operation.	P.22
4	Auto Start operation	This is used to “automatically start several hours” after turning power on. Press TIMER key to display “AStr”. You can press ENTER key to set a set temperature “Sv”. You can set an operation time “tim” by pressing ENTER key again. Pressing RUN/STOP key starts Auto Start operation.	P.24
5	Program operation	This is used to increase or decrease temperature above or below set temperature and depending on specific time periods. Press PROGRAM key to display “PrGn”. (n:1,2,3) Press PROGRAM key again to select a program mode you want. For “PrG2” and “PrG3”, press ENTER key to select a pattern “Pat” you want. Press RUN/STOP key to start program operation.	P.26
※You cannot change the operation mode while the unit is in operation. Be sure to first stop operation before trying to change the mode.			

4. Operating Procedures

List of operation modes and functional menus

Operation modes of this unit are as follows.

No.	Name	Description	Page
1	Overheat Preventive function	<p>Automatic Overheat Preventive function :</p> <p>The function has been set to automatically activate when in-bath temperature rises together with the unit set temperature to a temperature 12°C plus that temperature (automatic recovery).</p> <p>Overheat preventive device :</p> <p>The power supply unit, the display, and the key input assembly are common with the controller, while the device has an independent temperature detecting circuit, a CPU, sensors, and an output circuit, for which a temperature you want can be set on the operation panel. If the overheat preventive device has activated, the unit will stop and will not recover until the power switch is turned on again. (Manual recovery).</p>	P.19
2	Calibration Offset function	<p>The Calibration Offset function compensates any differences that may occur between the target in-bath temperature and the temperature on the controller (sensor temperature).</p> <p>You can compensate in plus or minus direction over the entire temperature range of the unit.</p>	P.34
3	Overheat Preventive Temperature Compensation function	<p>When you perform temperature compensation for the controller in item 2 above, temperature to be input to the overheat preventive device will also be compensated automatically.</p>	—
4	Power Failure Compensation function	<p>When a power failure occurred in the middle of operation and recovered, this function resumes operation at the status immediately before the failure.</p>	—
5	Setting Lock function	<p>This function is used to lock set operation status. You can set and cancel lock using the SUB MENU key.</p>	P.35

4. Operating Procedures

Operation mode and function setting keys and characters

The following key operations and characters are necessary for setting an operation mode and functions.

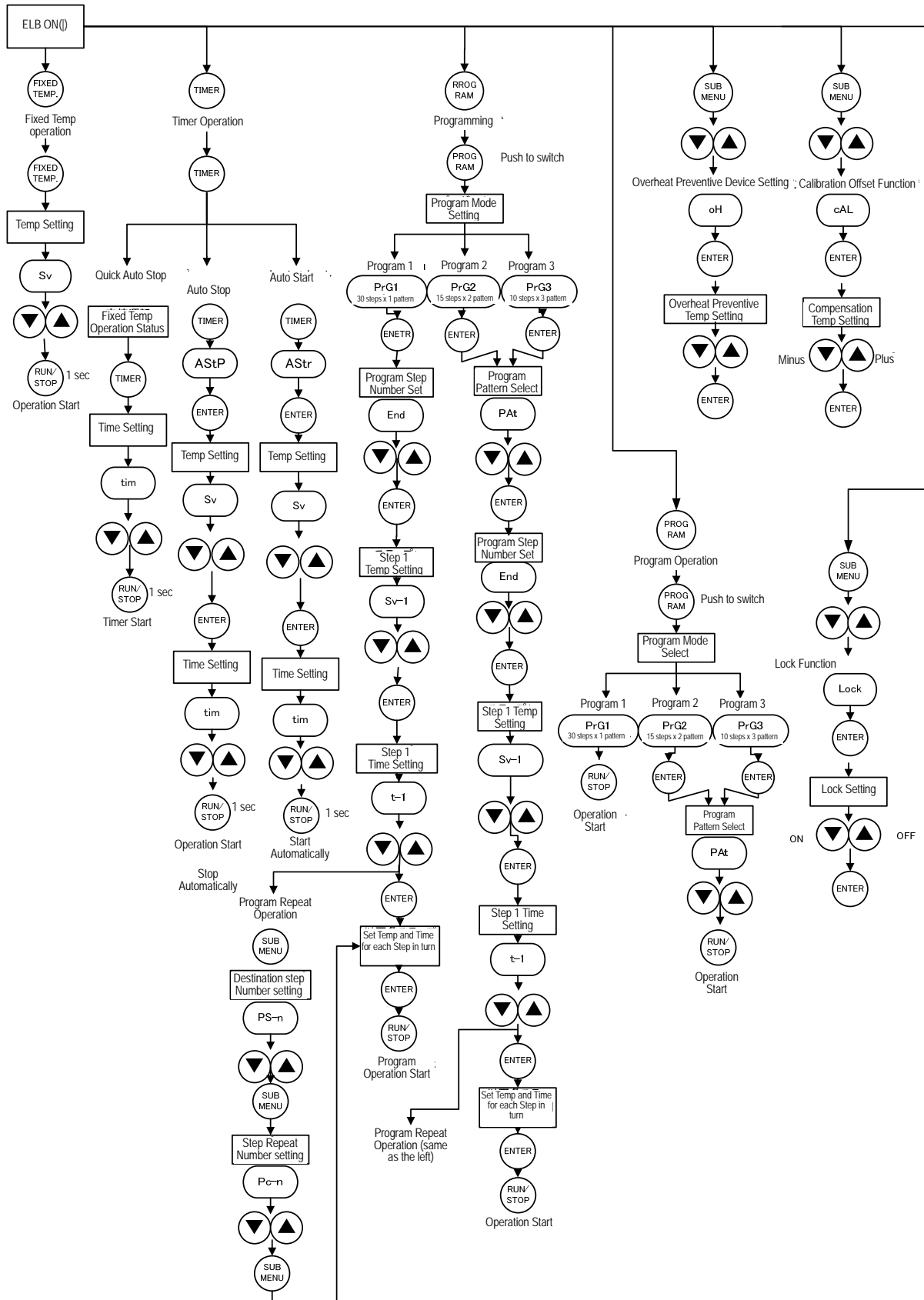

4. Operating Procedures

Setting of the overheat preventive device

The safety device to prevent overheat has the power supply, the display, and the key entry assembly common with the controller in addition to the automatic overheat preventive function (automatic recovery) of the controller. In addition to them the device has an overheat preventive device (manual recovery) consisting of an independent temperature detection circuit, a CPU, sensors, and an output circuit creating a two-fold safety mechanism.

Set temperature range and related functions

The unit has dual overheat preventive functions. One is integrated in the controller, which has been set to activate automatically at a temperature of 12°C + set temperature on the temperature controller at the time of factory shipping (the heater repeats ON/OFF at 12°C + the set temperature).

The other is integrated with the controller and is set with key operation on the controller.

This setting adds the second overheat preventive function.

The set temperature range for the overheat preventive device integrated with the controller is "0°C ~ highest set temperature of the unit +50°C".

If in-bath temperature should keep rising exceeding the controller set temperature and reach the set temperature of the overheat preventive device, the circuit will be shut off, Er19 will flash on the controller screen, and the buzzer keeps sounding.

When this overheat preventive device has activated, Er19 will be held without being released until you turn power on again.

How to set a temperature

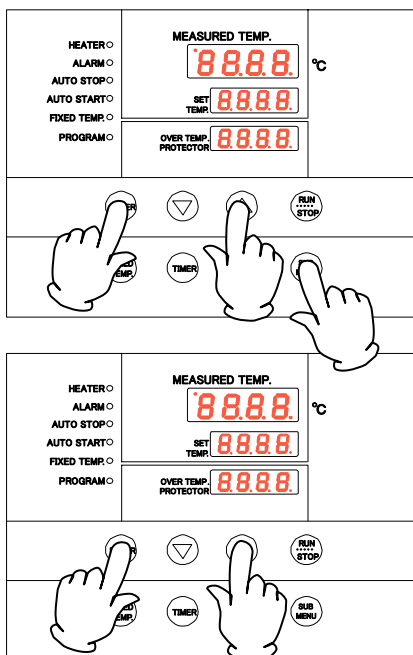

1. Turn power on (Turn ELB ON)

When you turn power on, the initial values will be displayed for about four seconds and the screen will change to the initial setting screen, and each of indicators displays the current in-bath temperature, operation mode characters, and overheat prevention set temperature.

2. Set an overheat preventive temperature

- ① Press **SUB MENU** key.
- ② Press **▽** and **△** keys to select the overheat preventive temperature setting character **oH** on the measured temperature indicator.
- ③ Pressing **ENTER** key will flash the current set temperature on the set temperature indicator.
Caution : Usually, set this temperature at least 20°C higher than the controller set temperature to prevent a wrong operation.
- ④ When the temperature you want is set with **▽** and **△** keys, press **ENTER** key to complete setting.

Caution

- ① Use "the highest temperature possible for this unit +20°C" or "Set temperature +20°C" as a rough standard" for set temperature and if a malfunction occurs at such settings, add about 5°C.
- ② Be sure to set temperature for overheat preventive function correctly. Otherwise, the device may not operate correctly, the overheat preventive device may erroneously activate while in-bath temperature is increasing, or a fire or other unexpected accidents may result.
The temperature has been set at 290°C at the time of factory shipping.
- ③ The overheat preventive device does not aim to protect specimens but to prevent overheat of devices. It is not able to prevent accidents caused by use of explosive or flammable materials.

4. Operating Procedures

Operation steps (Fixed temp operation)

How to start fixed temp operation

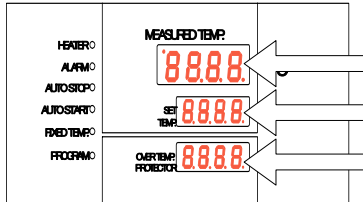

1. Turn power on (Turn ELB ON)

When you turn power on, the initial values will be displayed for about four seconds and the screen will change to the initial setting screen, and each of indicators displays the current in-bath temperature, operation mode characters, and overheat prevention set temperature.

Measured temp indicator : Displays the current in-bath temperature or characters.

Set temp indicator : Displays the set temperature or characters.

Overheat preventive set temp indicator : Displays the set temperature of the overheat preventive device.

For operation mode characters, see P.14.

2. Select an operation mode

Press **FIXED TEMP.** key to display Fix **F, 11** that means Fixed Temp operation on the set temperature indicator.

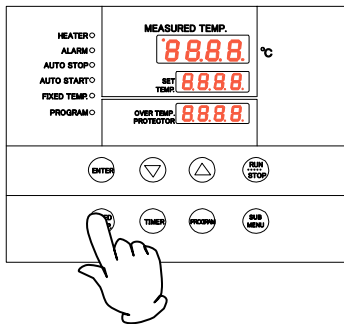

3. Set a temperature

Press **FIXED TEMP.** key again.

Display the character Sv **50** that means temperature setting on the measured temperature indicator, the current set temperature flashes on the set temperature indicator and the fixed temp operation lamp flashes.

Use **▽** and **△** keys to set a temperature you want.

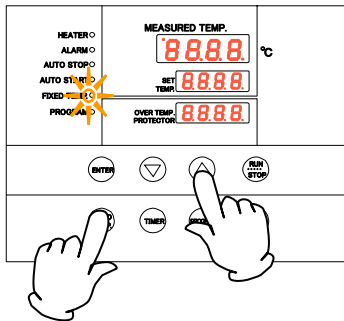

4. Start operation

Press **RUN/STOP** key for about one second. Operation starts and the Fixed Temp operation lamp will change from flashing to be lit.

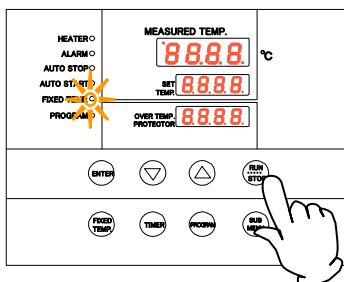

5. Stop operation

Press **RUN/STOP** key for about one second. Operations stops, the Fixed Temp operation lamp goes off and the screen switches to the initial setting screen.

If you want to correct wrong settings or to check settings

When you want to correct wrong settings or to check settings again, press **FIXED TEMP.** key and make settings again.

When you want to change the set temperature during operation, keep **FIXED TEMP.** key pressed to enter to the setting mode. After making changes, press **ENTER** key to complete setting.

4. Operating Procedures

Operation steps (Quick Auto Stop operation)

How to start quick auto stop operation

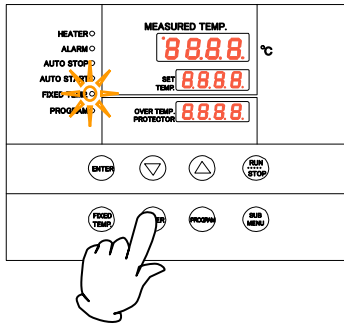

This operation mode is used to when you “want to stop Fixed Temp operation after several hours automatically in the middle of it”. Quick Auto Stop operation is a function to allow auto stop timer setting during operation.

1. Set time period before stop during Fixed Temp operation

Make sure that the Fixed Temp operation lamp is on indicating the unit is in the fixed temp operation mode.

Press **TIMER** key.

The characters tim **tin** that means a timer is displayed on the measured temperature indicator and the current set period of time flashes on the set temperature indicator.

Use **▽** and **△** keys to set a period you want.

About the timer function

Maximum settable time for the timer is 999 hours 50 minutes.

Time can be set in the unit of minutes up to 99 hours 59 minutes.

Time period 100 hours and longer shall be set in the unit of 10 minutes.

You can continuously change set time and change to the setting you want quickly by keeping **▽** and **△** keys pressed. Press **▽** and **△** keys once at a time to fine adjust a time.

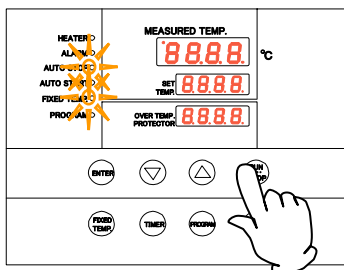

2. Start timer operation

When you have set a time you want, press **RUN/STOP** key for about one second. Timer operation will start when the Fixed Temp operation lamp and the Auto Stop lamp are lit. Timer starts when **RUN/STOP** key is pressed.

3. Stopping and ending Timer operation

Operation will stop automatically when the set time comes.

The buzzer sounds for about five seconds to tell you that operation has stopped. At this time, the set temperature indicator display the

character End **End** that means completion of operation with the Fixed Temp operation and the Auto Stop lamp are lit.

Press **RUN/STOP** key for about one second to end the Timer operation mode. The screen will switch to the initial setting screen.

When you want to correct a set temperature or a set time or check settings

When you want to change a set temperature during operation, keep **FIXED TEMP.** key pressed to enter the setting mode and change the temperature. After changing the temperature, press **ENTER** key to complete. When want to change a set temperature during operation, keep **TIMER** key to enter the setting mode and change the time. At this time, you need to set a time calculated by adding time period to add to the time already passed. After changing the setting, press **RUN/STOP** key to complete.

Press **▽** key to display the set temperature, the operation mode, and the remaining time on the set temperature indicator.

4. Operating Procedures

Operation steps (Auto Stop operation)

How to start Auto Stop operation

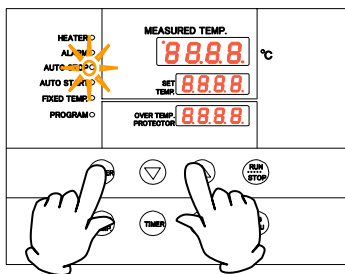
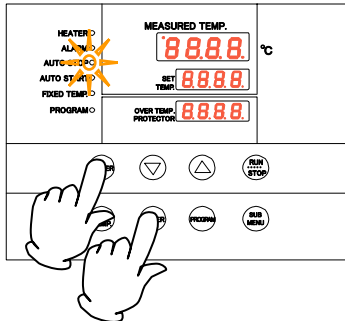

This is used when you "want to stop Fixed Temp operation automatically after set time from the beginning of that operation".

1. Setting a stop time

- ① In the initial screen, press **TIMER** key.
- ② The set temperature indicator will show the timer mode that you used in the last session.

Pressing **TIMER** key again will make the timer mode flash. Pressing **TIMER** key again will make the next timer mode flash.

Select the character **ASTP** that means the Auto Stop operation and press **ENTER** key.

The character **Sv** that means the temperature setting is displayed on the measured temperature indicator while the current set temperature and the Auto Stop lamp will flash on the set temperature indicator.

- ③ Press **▽** and **△** keys to set a temperature you want.
- ④ Press **ENTER** key. The character **tim** that means the timer is displayed on the measured temperature indicator and the current set time will flash on the set temperature indicator.
- ⑤ Use **▽** and **△** keys to set a time you want.

About the timer function

Maximum settable time for the timer is 999 hours 50 minutes. Time can be set in the unit of minutes up to 99 hours 59 minutes. Time period 100 hours and longer shall be set in the unit of 10 minutes. You can continuously change set time and change to the setting you want quickly by keeping **▽** and **△** keys pressed. Press **▽** and **△** keys once at a time to fine adjust a time.

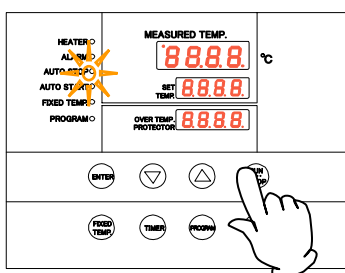

2. Starting the Timer operation

When you have set a time you want, keep **RUN/STOP** key pressed for about one second.

Timer operation starts with the Auto Stop lamp is lit.

The timer will start when the in-bath temperature (measured temperature) reaches the set temperature.

4. Operating Procedures

Operational steps (Auto Stop operation)

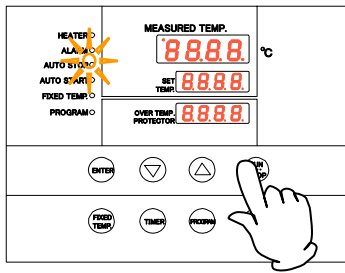

3. Stopping and ending Timer operation

Operation will stop automatically when the set time comes.

The buzzer sounds for about five seconds to tell you that operation has stopped. At this time, the set temperature indicator display the

character End End that means completion of operation with the

Auto Stop lamp is lit. Press RUN/STOP key for about one second to end the Timer operation mode. The screen will switch to the initial setting screen.

When you want to correct a set temperature or a set time or check settings

When you want to change the set temperature or the set time during operation, press TIMER key without stopping operation, set the temperature and the time for the Auto Stop operation using ▽ and △ keys and then press ENTER key for each setting.

But you need to set a time calculated by adding time period to add to the time already passed.

Pressing ▽ key during operation will display the set temperature, the operation mode, and the remaining time on the set temperature indicator.

The remaining time display 1.30 は means counting down while dots are flashing or means wait status (temperature is increasing or decreasing toward the set temperature) while dots stay lit and the timer count is stopped.

4. Operating Procedures

Operational steps (Auto Start operation)

How to start Auto Start operation

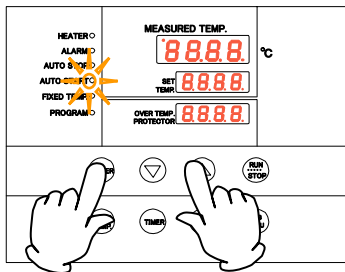
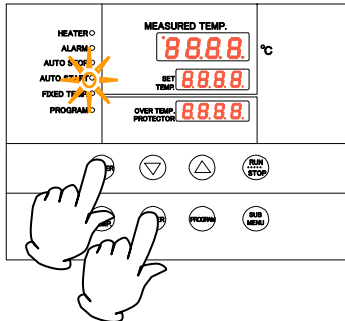

This is used when you “want to start operation automatically after the set time”.

1. Setting an operation start time

- ① Press **TIMER** key on the initial screen.
- ② The set temperature indicator will show the timer mode that you used in the last session.

Pressing **TIMER** key again will make the timer mode flash. Pressing **TIMER** key again will make the next timer mode flash.

Select the character **ASTr** that means the Auto Start operation and press **ENTER** key.

The character **Sv** that means temperature setting is displayed on the measured temperature indicator and the current set temperature and the Auto Start lamp will flash on the set temperature indicator.

- ③ Press **▽** and **△** keys to set a temperature you want.
- ④ Press **ENTER** key. The character **tim** that means a timer is displayed on the measured temperature indicator while the current set time flashes on the set temperature indicator and the Auto Start lamp flashes.
- ⑤ Use **▽** and **△** keys to set a time you want.

About the timer function

Maximum settable time for the timer is 999 hours 50 minutes.

Time can be set in the unit of minutes up to 99 hours 59 minutes.

Time period 100 hours and longer shall be set in the unit of 10 minutes.

You can continuously change set time and change to the setting you want quickly by keeping **▽** and **△** keys pressed. Press **▽** and **△** keys once at a time to fine adjust a time.

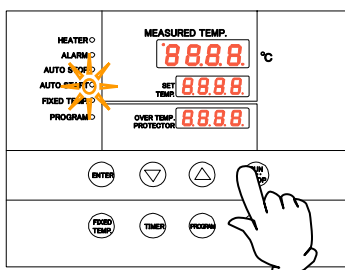

2. Starting Timer operation

When you have set a time you want, keep **RUN/STOP** key pressed for about one second.

Timer operation starts with the Auto Start lamp is lit.

4. Operating Procedures

Operational steps (Auto Start operation)

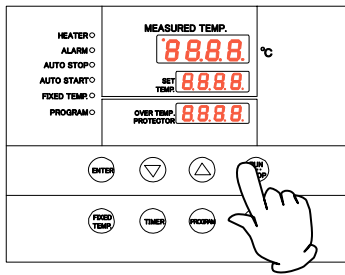

3. Stopping and ending the Timer operation

Operation starts automatically when the set time comes.

Press **RUN/STOP** key for about one second to stop or end operation. The screen changes to the initial setting screen.

When you want to correct a set temperature or a set time or check settings

When you want to change the set temperature or the set time during operation, press **TIMER** key without stopping operation, set the temperature and the time for the Auto Start operation using **▽** and **△** keys and then press **ENTER** key for each setting.

た But when you change the set time, you need to set a time calculated by adding time period to add to the time already passed. However, you need to set a time calculated by adding time period to add to the time already passed when you change the set time.

Pressing **▽** key during operation will display the set temperature, the operation mode, and the remaining time on the set temperature indicator.

Once the Auto Start time is passed and operation has started, you cannot change the setting. In this case, use **RUN/STOP** key to stop operation and make settings again.

4. Operating Procedures

Creating a program

Program operation

This is used when you "want to operate while increasing or decreasing temperature depending on time".

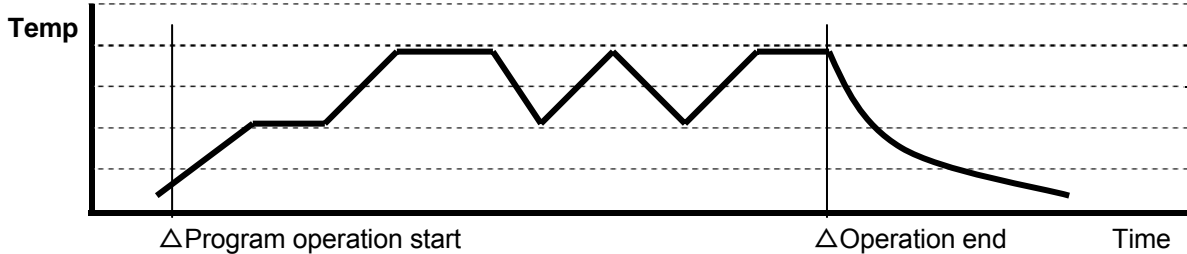

Program patterns

You can register up to six program patterns

PrG1	—	You can create one program pattern with up to 30 steps.
PrG2	PA t 1	You can create two program patterns with up to 15 steps each.
	PA t 2	
PrG3	PA t 1	You can create three program patterns with up to 10 steps each.
	PA t 2	
	PA t 3	

Before programming

You need to register (input) a program pattern in order to perform program operation.

- ① Use program creation sheets on P.32~33 of the operation manual, check the number of steps, temperature and time for each step beforehand.
- ② Check the temperature increasing and decreasing capacity of the unit. You need to set a time within the temperature increasing and decreasing capacity.

For example, for a unit that is able to increase or decrease temperature by 50°C for 10 minutes, about 20 minutes will be necessary to increase or decrease by 100°C from the current temperature.

- ③ Check if the controller has a free pattern that affords the number of steps you are going to program.

But if you use the Repeat function, the number of steps for that function can be excluded from occupied patterns.

Useful function

When the same program steps are to be repeated, you can use the useful Repeat function. See P.31 for how to use the Repeat function.

4. Operating Procedures

Creating a program

Temperature increase/decrease time for model DKG

The rough temperature increase/decrease time by 50°C for model DKG are as follows.

Numeric values mean required time between different temperatures. [Example : For DKG610, the time required to increase temperature from 100°C to 150°C would be about 20 minutes.] Be sure to set an appropriate time after conducting a trial run since time required for increasing/decreasing temperature will change depending on the exhaust air amount and loads and a time for the temperature to stabilize after the set temperature is attained shall be added or the increase/decrease time may be needed to extend.

Condition : Room temperature of 23°C No-load Exhaust port full open [Unit : minutes]

	DKG610/650		DKG810/850			DKG610/650		DKG810/850	
	Rise time	Fall time	Rise time	Fall time		Rise time	Fall time (Exhaust port full open)	Rise time	Fall time (Exhaust port full open)
260°C	20	-	20	-					
250°C	30	20	30	10	25°C⇒	45	/	50	/
200°C	25	35	30	35	260°C				
150°C	20	40	25	35	260 °C	/	170 (30)	/	170 (40)
100°C	15	45	20	50	⇒				
50°C	10	80	10	105	50°C				

Creating a program

Description here uses an example of a program pattern below.

Temp

1.Example program pattern

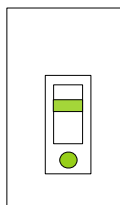
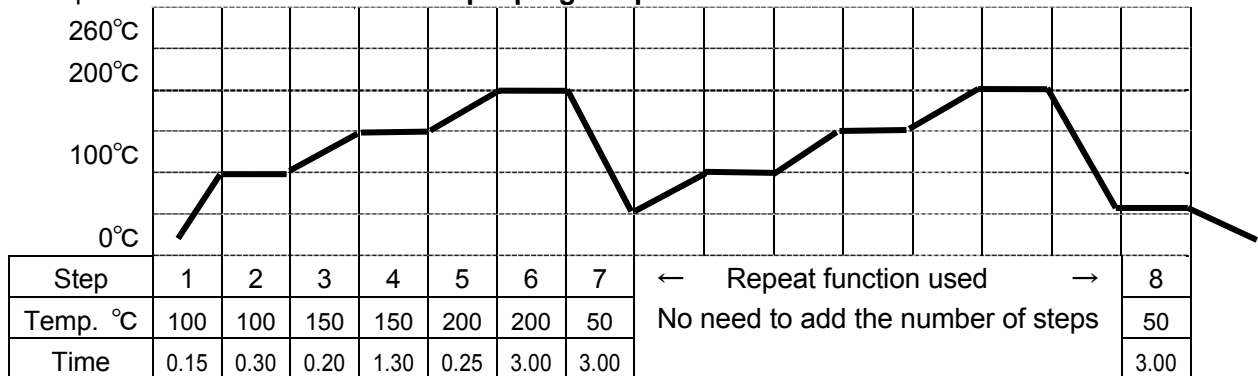

2. Turn power on (Turn ELB ON(!))

When you turn power on, the initial values will be displayed for about four seconds and the screen will change to the initial setting screen, and each of indicators displays the current in-bath temperature, operation mode characters, and overheat prevention set temperature.

3.Selecting a program mode and a program pattern

① Press **PROGRAM** key.

The set temperature indicator displays the program mode use in the last session.

Pressing **PROGRAM** key again will make the program mode flash.

Pressing **PROGRAM** key again will make the next program mode flash.

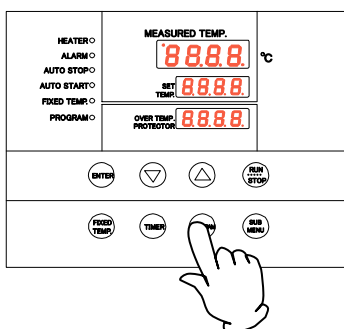

4. Operating Procedures

Creating a program

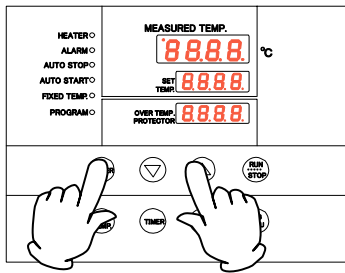

② Select a program mode you want and press **ENTER** key.

• When you have selected PrG1 **PrG1**, the measured temperature indicator displays End **End** and the number of registered steps flash on the set temperature indicator.

• When you have selected PrG2 **PrG2**, the measured temperature indicator displays PAT **PAT** and the pattern number will flash on the set temperature indicator. Select pattern "1" or "2" with **▽** and **△** keys.

Pressing **ENTER** key displays End on the measured temperature indicator and the number of registered steps will flash on the set temperature indicator.

• When you have selected PrG3 **PrG3**, select a pattern "1", "2", or "3" with the same procedures as for PrG2.

The program in the example uses up to eight steps, which can be input for any program mode you select from PrG1, PrG2, or PrG3.

This section describes how to register a program when PrG3 is used as an example.

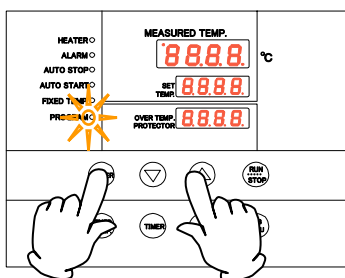

4. Registering a program (Inputting a program)

① Select PrG3 following the steps in the previous item 3.

② As per the programming sheet you have filled, input the number of program steps, step temperatures, and step time.

③ Press **ENTER** key. Pat number will flash. (End will be displayed when you have selected PrG1. Move to item ⑥.)

④ Use **▽** and **△** keys to select a free pattern from PAT1, PAT2, and PAT3.

⑤ Press **ENTER** key. End is displayed and the number of steps "n" will flash.

※End is a character that indicates the total number of steps to be used. In the example, you will enter "8".

⑥ Enter the total program step number to use "8" with **▽** and **△** keys.

⑦ Press **ENTER** key. The character Sv-1 **Sv-1** that means the set temperature for the first step will be displayed and the current set temperature flashes.

⑧ Use **▽** and **△** keys to set the temperature for the first step.

4. Operating Procedures

Creating a program

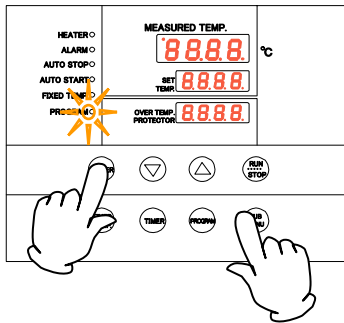

- ⑨ Press **ENTER** key. The character t-1 **t-1** that means the set time for the first step will be displayed and the current set time flashes.
 - ※Before setting a time, you need to know the temperature increasing (or decreasing) capacity of the unit.
 - ※As an example, about 45 minutes are required to increase from room temperature to 260°C for the model DKG610. Thus as a rough guideline, temperature will rise by about 5°C for one minute. In actual setting, set a time slightly longer including a time necessary for stabilizing.
 - ※Maximum settable time for the timer of each step is 999 hours 50 minutes.
- ⑩ When you have set a time, press **ENTER** key. The temperature setting character Sv-2 for the second step is displayed. Then repeat the same steps as per the program sheet to input temperatures and time for each step.
- ⑪ When you want to repeat a program pattern in the middle of a program as in the example (program repeat), a special procedures are necessary. In such a case, first set a time (t-7 in the example) for the step you want to perform repeat operation (step 7 in the example) and press **SUB MENU** key without pressing **ENTER** key. Now you can enter the Repeat function setting mode.
 - ※For operation and registration (input) procedures for the Program Repeat function, follow “Program Repeat operation” on P.31.
- ⑫ When you have set temperature and time for the final step, the screen will return to the initial setting screen.

Request for Check operation

Be sure to perform no-load operation to check whether the set temperature and the set time are correct before attempting actual operation with specimens.

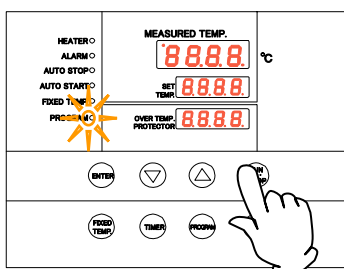

5.Starting Program operation

Press **RUN/STOP** key for about one second. The Program operation you have set will start.

The Program operation lamp comes on and the Set Temperature indicator will show steps being operated from the step St-1 **St-1** first.

※You can press the **▼** key during operation to check the set temperature and the remaining time for each step being operated on the set temperature indicator.

4. Operating Procedures

Creating a program

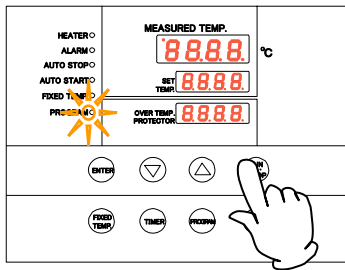

6. Ending the Program operation

When the Program operation has ended, the buzzer will sound for about five seconds.

The set temperature indicator displays the character “End” that means the completion of operation.

Press **RUN/STOP** key to return to the Initial setting screen.

About the timer function

Maximum settable time for the timer is 999 hours 50 minutes.

Time can be set in the unit of minutes up to 99 hours 59 minutes.

Time period 100 hours and longer shall be set in the unit of 10 minutes.

You can continuously change set time and change to the setting you want quickly by keeping **DOWN** and **UP** keys pressed. Press **DOWN** and **UP** keys once at a time to fine adjust a time.

If you want to correct wrong settings or to check settings

If you want to return to the previous step, for example, to correct a wrong program or to check settings again, press **FIXED TEMP.** key to return the Setting screen to the previous one.

Each time you press **FIXED TEMP.** key, you will go back by one step.

Note : Be sure to perform this operation in the Program Setting screen.

About wait action during the Program operation

When a program moves from one step to the next, the next step will not start if measured temperature has not reached the set temperature or has exceeded it when the step set time has elapsed.

Note that the unit has been set so that steps will move to the next in the range of $\pm 3^{\circ}\text{C}$ to the set temperature.

4. Operating Procedures

Program repeat operation

Using the Program Repeat function

This section describes how to register a repetition of a program pattern (program repeat) for the Program operation.

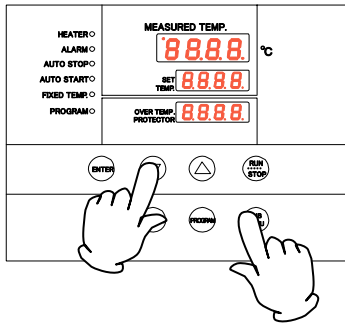

Using the Program Repeat function

This section describes how to register a repetition when using the Program Repeat function in the middle of registration of a program in the previous item 4.

This step will set a step number to return to "PS-n" and a number of repetitions "Pc-n" (n : Step number for repeat input)

- ① First set a time (t-7 in the example) for the step you want to perform repeat operation (step 7 in the example), and press **SUB MENU** key without pressing **ENTER** key. Now you can enter the Repeat Function Setting mode.
- ② The measured temperature indicator displays the character "PS-n" that means the "Selecting a step to return to" for a program pattern. In the example, the repeat function is input for the seventh step and the measured temperature indicator will display PS-7 **PS-7**.

In the set temperature indicator, you can input a number of 1 ~7 of steps to return to (1 in the example) using **▽** and **△** key.

- ③ Then press **SUB MENU** key.
The measured temperature indicator displays the character "Pc-n" that means "a number of repetitions". Input a number (2 in the example) using **▽** and **△** keys.
- ④ Pressing **SUB MENU** key again moves the screen to the next step. In the example, the screen will move to the Sv-8 registration screen.

If you want to correct wrong settings or to check settings

You cannot make corrections in the middle of the Repeat Setting mode.

If you want to return to the previous step, for example, to correct a wrong setting or check settings again, first finish repeat setting, press **FIXED TEMP.** key when the screen switches to the temperature setting screen for the next step, return the Setting screen to the previous one and redo the repeat setting operations.

Note : Be sure to perform this operation in the Program Setting screen.

If you have any questions, contact a nearest sales office or our general customer service center.

4. Operating Procedures

Program sheet

Make duplicates as many as you need

Register to	PrG1	PrG2	PrG3	PA1	PA2	PA3	Management No.	
Test name							Date	
							Prepared by	

Program inputs

	Set temperature (°C)	Set time (Time : min)	Repeat function input (Return to : number)
Step 1		:	:
Step 2		:	:
Step 3		:	:
Step 4		:	:
Step 5		:	:
Step 6		:	:
Step 7		:	:
Step 8		:	:
Step 9		:	:
Step 10		:	:
Step 11		:	:
Step 12		:	:
Step 13		:	:
Step 14		:	:
Step 15		:	:
Step 16		:	:
Step 17		:	:
Step 18		:	:
Step 19		:	:
Step 20		:	:
Step 21		:	:
Step 22		:	:
Step 23		:	:
Step 24		:	:
Step 25		:	:
Step 26		:	:
Step 27		:	:
Step 28		:	:
Step 29		:	:
Step 30		:	:

4. How to operate the unit

Useful functions (calibration offset function)

Using the calibration offset function

The calibration offset function compensates any difference between the target in-bath temperature and the control temperature of the controller (sensor temperature). You can apply parallel compensation to the plus or minus side over the entire temperature range of the unit. You can set/cancel this function with the **Sub menu** key.

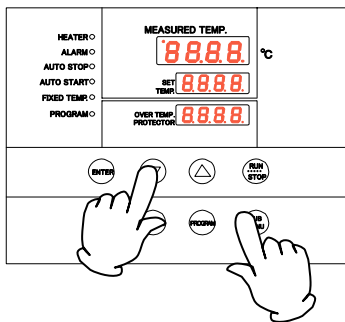
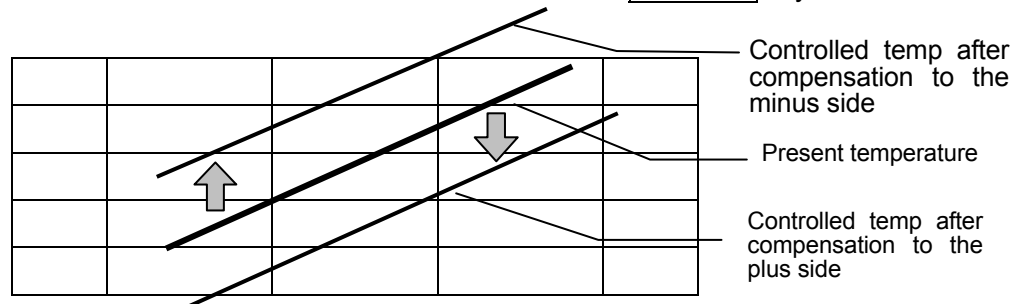

- ① Start operation at the target set temperature and check the in-bath temperature (sample temperature) on a temperature recorder when the temperature is stable.
 - ② Check the difference between the set temperature and the in-bath temperature (sample temperature).
 - ③ Press the **Sub menu** key again to select the character cAL **cAL** that mean calibration offset and then press the **Start/Stop** key.
 - ④ Enter the difference between the set temperature and the in-bath temperature with **▽** and **△** keys and press the **Sub menu** key longer to finish setting.
- ※ You can set an offset compensation temperature to either + or – side up to +99°C and -99°C respectively.
Setting to the – side will decrease the temperature on the measured temp indicator by the compensated temperature and the in-bath temperature will increase by that amount accordingly. Setting to the + side will increase the temperature on the measured temp indicator by the compensated temperature and the in-bath temperature will decrease by that amount accordingly.
 - ※ Inputting a too large compensation may make difference between the actual temperature and the displayed temperature larger and cause a dangerous situation. Contact a nearest sales office or our general customer service center before inputting a larger compensation value.
 - ※ The unit has a two-point compensation function that adjusts offset for the lower temperature region and the high temperature region in addition to the calibration offset function and adjusting temperatures have been set at the time of factory shipping.
 - ※ When validating the temperature indicator, first consult with your nearest sales office or the customer support center.

4. Operating Procedures

Useful function (Lock function)

Using the Lock function

This is a function used to lock operating conditions you have set. You can set and cancel this function using **SUB MENU** key.

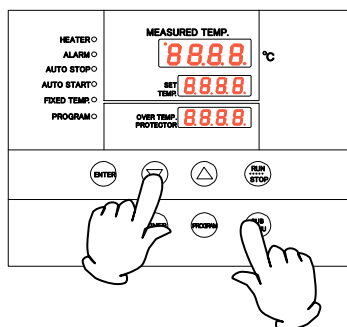

- ① Press **SUB MENU** key, select the character Lock **Lock** that means setting lock with **▽** and **△** keys and press **ENTER** key.
 - ② The set temperature indicator displays “OFF”. Use **△** key and change it to “ON” to lock the settings.
 - ③ To cancel lock, press **SUB MENU** key again, select the character Lock **Lock** that means setting lock with **▽** and **△** keys and press **ENTER** key.
Select “OFF” with **▽** key and press **ENTER** key to cancel.
- ※ While the Lock function is “ON”, any keys other than **RUN/STOP** key and **SUB MENU** key are locked.

4. Operating Procedures

Useful function (External alarm output)

External alarm output specifications

- Outputs when an abnormality is detected (For description of abnormalities, see “Safety device and error codes” on P.56.)
- A-contact (relay contact)
- Contact capacity : AC250V 3A (resistance load)
DC30V 3A (resistance load)
- Connection : M4 screw terminal block
 - ※ Be sure to operate the unit at the rated capacity or below.
 - The setting will be "ON" (relay contact close) while outputting an alarm.

Connecting procedures

Be sure to turn the ELB OFF before make connections. Use the screws on the terminal block to secure connections.

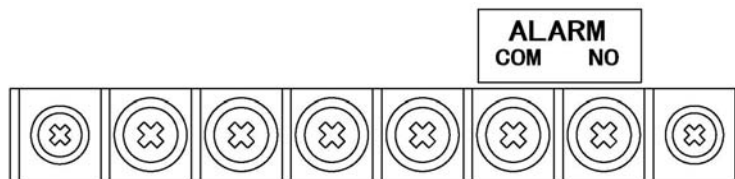

Connection terminal

- ※ When the optional auto damper is installed, the standard external alarm output terminal will be eliminated and the time-up output terminal will be used instead. For the time-up output terminal, see “Optional parts (output terminal)” on P.37.

4. Operating Procedures

Useful functions (Output terminal)

Before operating the unit



Be sure to follow instructions in this manual for operating the product. Operations other than those specified in this manual may cause a trouble. Also take care that the warranty may be void if any operation other than those specified in this manual is performed.



CAUTION



1. Be sure to turn the breaker OFF before making any connections.
2. Be sure to use the unit at or below the rated capacity when you use the alarm output and the time-up output.
3. Be sure to connect a recorder having an input impedance of 600Ω or less to the temperature output terminal.
4. Make any connection secure with the screws attached to the terminal block.

Connecting procedures



- Securely connect to the terminal to be used.
- The alarm output and the time-up output are “ON” (relay contact closed) at the time of outputting.
- When temperature output is used, use a shielded cable to prevent noises.

Layout 1

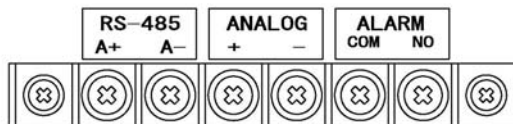

Layout 2

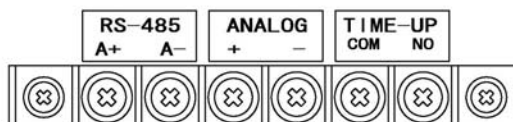

Connection terminal

※ You cannot install the time-up output terminal and the alarm output terminal at the same time. Note that the standard external alarm output terminal will be eliminated when you install the time-up output terminal.

When you install all output terminals, two layouts 1 and 2 above are possible.

4. Operating procedures

Useful functions (Output terminal)

Specifications

Temperature output (ANALOG)	<ul style="list-style-type: none"> • Outputs a voltage (DC) according to the measured temperature • Output temperature range : 0~270°C • Output current : 4~20mA • Output accuracy : ±2°C • Connection : M4 screw terminal block
Time up output (TIME UP)	<ul style="list-style-type: none"> • Outputs on time-up of AUTO STOP, AUTO START or QUICK AUTO STOP or at program end. • A-contact (relay contact) • Contact capacity : AC250V 3A (resistance load) DC30V 3A (resistance load) • Connection : M4 screw terminal block

Temperature (°C)	Output current (mA)	Converted voltage examples※ (V)
0	4.00	1.00
20	5.19	1.30
40	6.37	1.59
60	7.56	1.89
80	8.74	2.19
100	9.93	2.48
120	11.11	2.78
140	12.30	3.08
160	13.48	3.37
180	14.67	3.67
200	15.85	3.96
220	17.04	4.26
240	18.22	4.56
260	19.41	4.85
270	20.00	5.00

※ <Reference value when voltage is input to the temperature recorder>

Converted voltage when shunt resistances (250Ω) are connected to the recorder input terminals parallel (V=RI : Ohm's law)

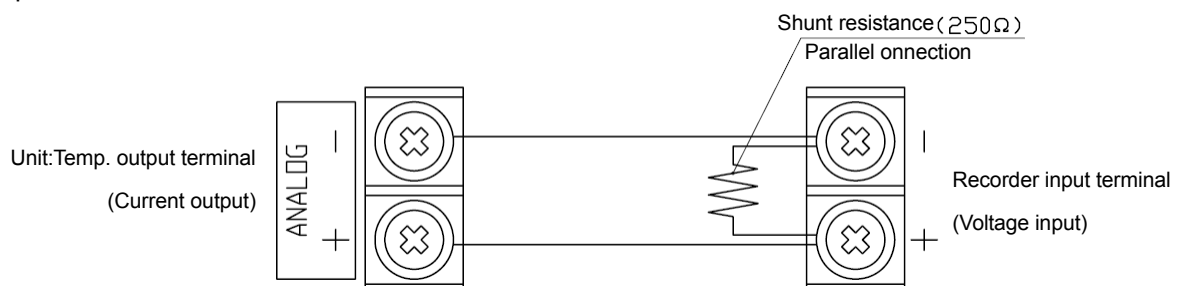

4. Operating procedures

Option (Overheat preventive unit)

The stand-alone overheat preventive unit consists of a temperature measurement circuit, CPU, sensors, and the output circuit separate from the controller. When the preventive unit is activated, "Er03" is occurred and the unit will stop and will not recover until the earth leakage breaker is turned on again. (Manual recovery)

Temperature setting for the stand-alone overheat preventive unit

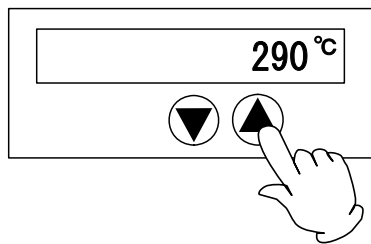

- ① Set the temperature with the ▼▲ keys.
(Set temperature range : 0~400°C)

About the stand-alone overheat preventive unit



When the difference in the set temperatures between the stand-alone overheat preventive unit and the controller is small, the preventive unit may be activated and operation may be stopped. Set a temperature for the independent overheat preventive unit at a temperature at least 20°C higher than that for the controller or to the set temperature for the controller overheat preventive unit or higher. Note that the overheat preventive unit is not available for the purpose of protecting specimens.

The temperature is set at 270°C at the time of shipping.

If you want to operate the stand-alone overheat preventive unit at a temperature you want, first operate the unit with the temperature in the bath at that setting until operation becomes stable, then gradually lower the preventive unit setting and make sure that it operates reliably at the temperature setting you want. It takes about five seconds before it starts operation for which time you have to wait before checking. When the preventive unit is triggered, it displays Er03 and operation stops. Since the activation temperature for the sensor of the preventive unit differs depending on overshoot at the time of heating or specimen status, set it at as high temperature as possible.

Also, when the preventive unit set temperature has been changed, wait for about five seconds until that temperature is recorded before turning power off.

4. Operating procedures

Option (RS485 communication function)

1. Communication settings

1.1 Communication settings

Make communication parameter settings on the PC side before starting communication with the CR5 controller (hereafter, "this Unit").

	Item	Communication settings
1	Data length	8 bits
2	Stop bit length	2 bits
3	Parity	None
4	BCC check	Enabled
5	Communication rate	4800BPS
6	Response delay time	0msec

1.2 Connection for communication

■ PC

- One RS232C interface channel (COM1/COM2 port) is used.

■ RS232C/RS485 converter

- We recommend a converter KS-485 of System Sacom.
- By purchasing our non-standard accessory "external communication adaptor (RS485-232C) ODK18", you can make following connection. (PC unit is excluded.)
- Sample program can be viewed in our home page.
<http://www.yamato-net.co.jp/support/program/index.htm>

■ Connection communication cable

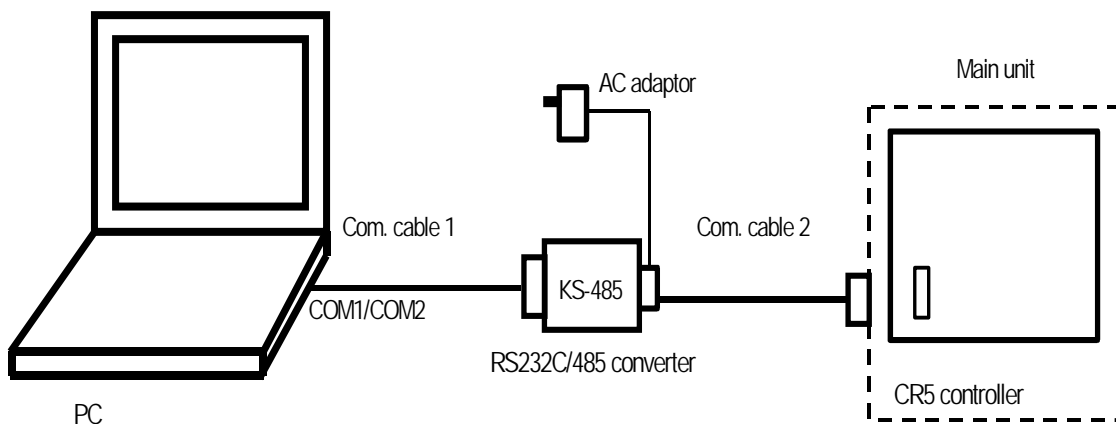

Note 1) Configuration of the non-standard accessory, "external communication adaptor (RS485-232C) ODK18" is as follows.

- ① Com cable 1 : PC side connector (for connecting IBM9 pin device)RS-232C cable 1m, KS-485 side connector (Dsub25 pin, male) System Sacom CBL16
- ② Com cable 2 : KS-485 side connector (Dsub9 pin, male) UL2464TASB 2-core AWG20 cable 3m, with a Y-terminal on the device side (with terminal resistance of 100Ω)
- ③ RS-232C↔KS-485 converter unit : System Sacom KS-485, with an AC adaptor

4. Operating procedures

Option (RS485 communication function)

2. Data transmission system

Item	Specifications
Communication standard	EIA standard RS-485 compliant
Synchronization system	Asynchronous system
Communication system	Half-duplex communication
Transmission code	ASCII code
Communication rate	1200/2400/ <input type="checkbox"/> 4800/9600BPS
Communication dist.	Max.500m (depends on environmental influences)
Network	Multi-drop system (Max. 1:31 stations)
Signal wire	Two wires: transmission/reception
Stop bit length	1/ <input type="checkbox"/> 2bits
Data length	7/ <input type="checkbox"/> 8bits
Parity	<input type="checkbox"/> None/Odd/Even
BCC check	<input type="checkbox"/> Enabled/Disabled
Response delay time	<input type="checkbox"/> 0~250msec
Communication address	<input type="checkbox"/> 1~99 stations (Max. 1:31 stations)
Communication mode select	RO/ <input type="checkbox"/> RW

Note) Settings indicated in are the initial settings of the Unit.

3. Transmission control characters

Symbol	Name	Code	Description
STX	Start of text	02H	Indicates the beginning of a text
ETX	End of text	03H	Indicates the end of a text
R	Read	52H	Command to read a request
W	Write	57H	Command to write a request
ACK	Acknowledge Character	06H	Transmission of acknowledgement of proper reception
NAK	Negative Acknowledge	15H	Transmission of reply of reception error

Note) R : Read (Command to read settings or measurements)

W : Write (Command to write settings)

R command can be always available for communication in any mode.

W command is available for communication only in the normal mode and its specific parameters that can be communicated differ depending on the operating status (during operation). See "Option (RS485 communication function) 7. List of identifiers/commands" on page 49.

4. Operating procedures

Option (RS485 communication function)

4. Transmission control procedures

4.1 Communication procedures

- The Unit returns “reply message” in response to a “request message” from a host PC.
Thus, the Unit will never start transmission.
- The Unit does not make any communication for about four seconds after power on (no reply).
Set some delay before start of communication after power on.

4.2 Message types

- Types of messages include the transmission request message from a host PC and the transmission reply message from the Unit.
- All code (excluding BCC) including STX, address, request content, identifier, and ETX are expressed in ASCII codes.

4.3 Configuration of the request message (Transmission from a host PC to the Unit)

4.3.1 Configuration of the read request message

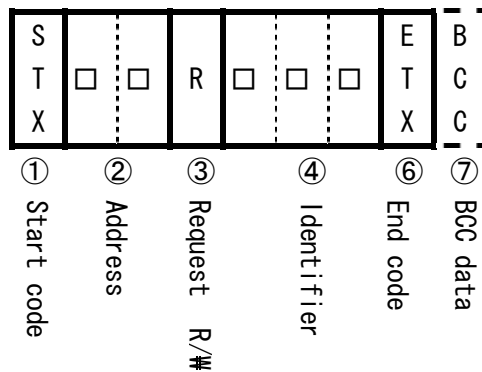

4.3.2 Configuration of the write request message

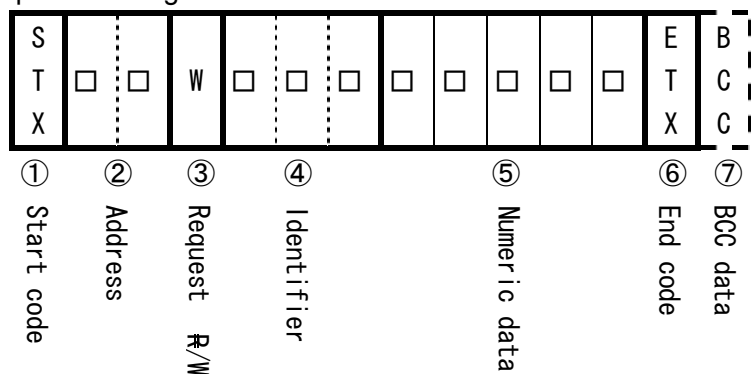

4. Operating procedures

Option (RS485 communication function)

4.4 Configuration of the reply message

4.4.1 Reply message in response to the read request message

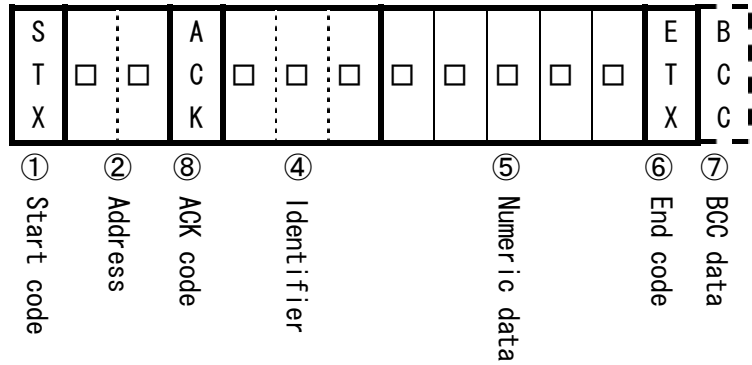

4.4.2 Reply message in response to the write request/store request messages

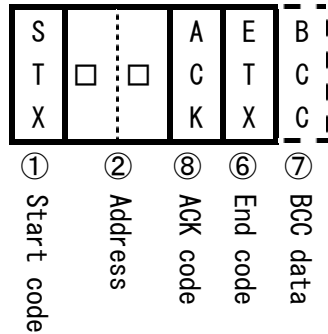

4.4.3 Reply message when an error occurs

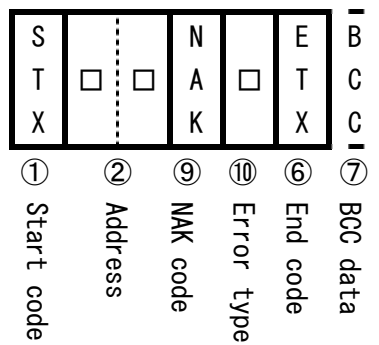

4. Operating procedures

Option (RS485 communication function)

4.5 Description of codes

- Codes below from ①STX, ②Address ⑩Error type are expressed in ASCII codes.
- For ASCII codes, see “8.ASCII code list” on page 51.
- For conversion to ASCII codes, see “5.Communication example” on page 46.

① STX

This code is necessary for the receiving side to detect the beginning of a message. This is prefixed to the beginning of the character string to be transmitted.

② Address

This is the address of the counterpart (the Unit) for communication with a host PC. The address within a reply message from the Unit indicates the transmission source of the reply message.

③ Request

Indicate R or W symbol.

R : When data is read out from the Unit

W : When data is written into the Unit or stored in the Unit.

④ Identifier

This is a classification symbol (identifier) for data to be read out or written and is expressed in a three-digit ASCII code. See “7. Identifier/command list” on page 49.

⑤ Numeric data

This is data to be read out or written all of which are expressed in a five-digit number irrespective of their type.

Minus data : The “-” symbol is indicated at the first digit.

Decimal point position : A five-digit data does not contain a decimal point.

Example) Five-digit numeric data 0 0 1 0 1 has the following meanings:

Example		Meaning
Set temp. (SV1)	When temp. sensor is a thermocouple	→ 101°C
	When temp. sensor is of platinum	→ 10.1°C
Set time (TIM)		→ 1 hr 1min

⑥ ETX

This is a code necessary for the receiving side to detect the end of a message. This is suffixed to the end of a character string to be transmitted. (Excluding BCC)

4. Operating procedures

Option (RS485 communication function)

⑦ BCC

This is a check code for error detection and is an exclusive OR (EX-OR) of all characters from STX to ETX. This code (BCC) will not be embedded in a reply message when the item BCC check for communication setting is set to "None".

⑧ ACK

This is an acknowledgement code and is returned embedded in a "reply message" from the Unit when the message received with the Unit contains no error.

⑨ NAK

This is a negative acknowledgement code and is returned embedded in a "reply message" from the Unit when the "request message" received with the Unit contains an error.

⑩ ERR type

When a "request message" received with the Unit contains an error, its description is embedded after "⑨NAK" in the "reply message" from the Unit.

This is a communication error and its detailed expression is omitted here.

Reception timeout means a case STX is not sent from the Unit after some response wait time after a host PC has sent BCC.

4. Operating procedures

Option (RS485 communication function)

5. Communication example

5.1 Communication example to be read out

Example) Request message: This message requests read-out of PV to the Unit addressed to address02.

Reply message from the Unit to this: PV data (00123) is returned.

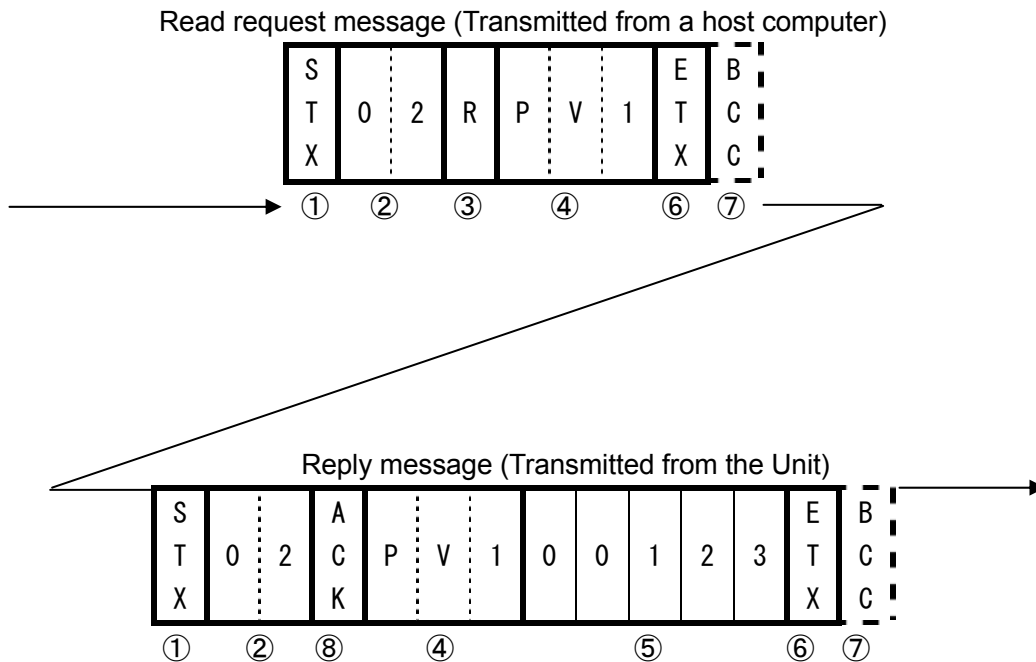

Code	Symbol/data	ASCII code note 2)
① Start code	STX	02H
② Address	02	30H 32H
③ Request (Read)	R	52H
④ Identifier note 1)	PV1	50H 56H 31H
⑤ Numeric data	00123	30H 30H 31H 32H 33H
⑥ End code	ETX	03H
⑦ BCC data Request		61H
Reply		02H
⑧ Acknowledgement code	ACK	06H

Note 1) See "7.Identifier/command list" on page 49.

Note 2) For ASCII codes, see "8.ASCII code list" on page 51.

4. Operating procedures

Option (RS485 communication function)

5.2 Example of write communication

Example) Request message: This message requests the Unit addressed to address03 to set "SV setting to 135" (write 135).

Reply message from the Unit to this: Returns acknowledgement that the request message was received.

☆Check that the message has been correctly written by separately reading out the data.

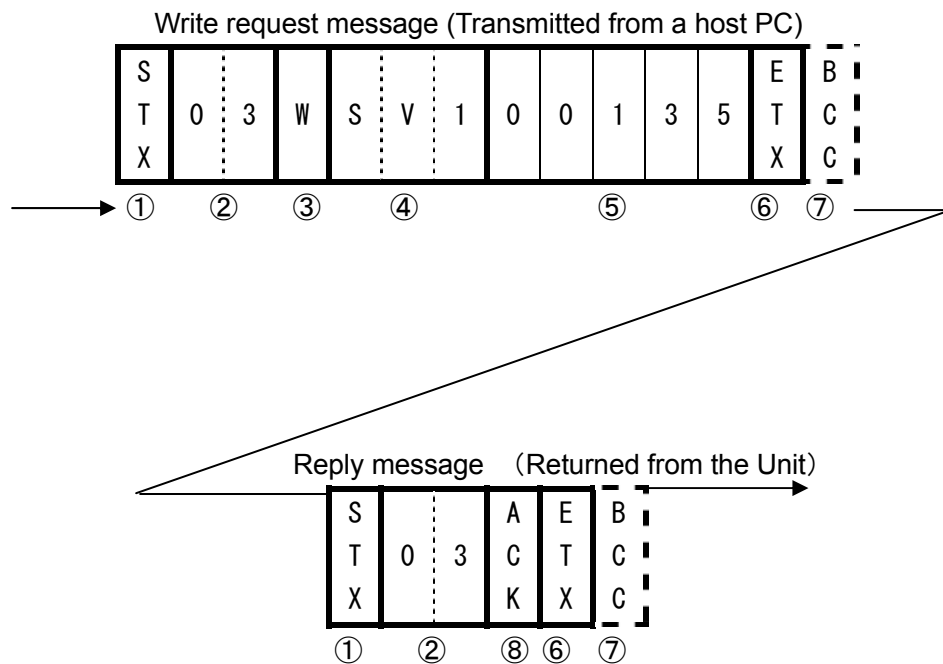

Code	Symbol · data	ASCII code note2)
① Start code	STX	02H
② Address	03	30H 33H
③ Request (Write)	W	57H
④ Identifier note 1)	SV1	53H 56H 31H
⑤ Numeric data	00135	30H 30H 31H 33H 35H
⑥ End code	ETX	03H
⑦ BCC data	Request	56H
	Reply	04H
⑧ Acknowledgement code	ACK	06H

Note 1) See "7.Identifier/command list" on page 49.

Note 2) For ASCII codes, see "8.ASCII code list" on page 51.

4. Operating procedures

Option (RS485 communication function)

6. Wire connection

Shown below is an example of the multi drop connection.

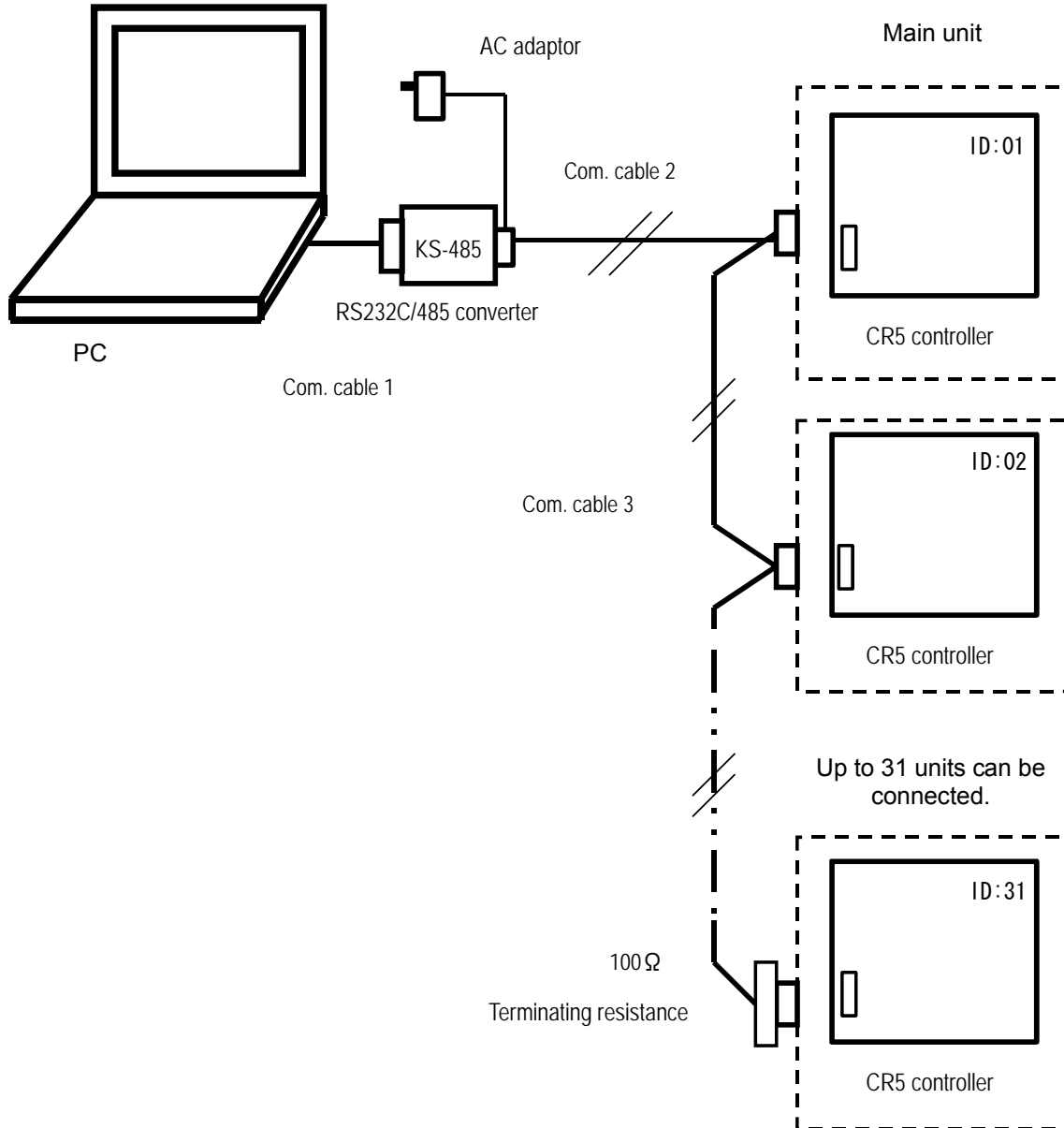

Note1) Com. cable 1: PC side connector (for connecting IBM9 pin device) RS-232C cable 1m, KS-485 side connector (Dsub25 pin, male) System Sacom CBL16

Note2) Com cables 2, 3: These must be separately ordered.

Note3) Terminating resistance: This must be separately ordered. If the customer prepares this, be sure to connect a fixed resistor of at least 100 Ω 1/4W to the final cable device terminal block.

4. Operating procedures

Option (RS485 communication function)

7. Identifier / command list

<About identifiers and settings>

- *1 : When the time exceeds 100 hours, setting unit will be one hour.
- *2 : _ indicates a space.
- *3 : Settable range will differ depending on other parameters. (See the table below.)
- *4 : For program NO. 2, identifiers of steps 1~15 of pattern NO.2 are [x16~x30].
For program NO.3, identifiers of steps 1~10 of pattern NO.2 are [x11~x20].
For program NO.3, identifiers of steps 1~10 of pattern NO.3 are [x21~x30].
- *5 : The W command is effective during operation of these parameters. (Effective while operation is active in the normal mode.)

Fixed Temp. Operation mode

Name	Identifier	Command	Setting
Temperature setting	SV1	R/W	SLL ~ SLH : Lower setting limit ~ upper setting limit °C *3*5

Programm Operation mode

Name	Identifier	Command	Setting
Program select	RPG	R/W	00001 : Program NO.1 select 00002 : Program NO.2 select 00003 : Program NO.3 select
Program NO.2 Pattern select	PT2	R/W	00001 : Pattern NO.1 select 00002 : Pattern NO.2 select
Program NO.3 Pattern select	PT3	R/W	00001 : Pattern NO.1 select 00002 : Pattern NO.2 select 00003 : Pattern NO.3 select
Program NO.1 Final step setting	E11	R/W	00001~00030 : Step 1~step 30
Program NO.2 pattern NO.1 Final step setting	E21	R/W	00001~00015 : Step 1~step 15
Program NO.2 pattern NO.2 Final step setting	E22	R/W	00001~00015 : Step 1~step 15
Program NO.3 pattern NO.1 Final step setting	E31	R/W	00001~00010 : Step 1~step 10
Program NO.3 pattern NO.2 Final step setting	E32	R/W	00001~00010 : Step 1~step 10
Program NO.3 pattern NO.3 Final step setting	E33	R/W	00001~00010 : Step 1~step 10
Step 1 ~ 30 temperature setting	S01~S30	R/W	SLL~SLH : Setting lower limit~setting upper limit °C *3 *4 *5
Step 1~30 time setting	T01~T30	R/W	00000~99950 : 0 hour 0 min~999 hour 50 min *4 *5
Step 1~30 return destination setting	R01~R30	R/W	00001~00030 : Step 1~step 30 *4
Step 1 ~ 30 number of execution setting	C01~C30	R/W	00001~00099 : 1~99 times

4. Operating procedures

Option (RS485 communication function)

Store command

Name	Identifier	Command	Setting
Storage of settings	STR	W	N/A (Command necessary to store temperature and time settings)

Other parameters

Name	Identifier	Command	Setting
Key lock	LOC	RW	00000 : Key lock release 00001 : Key lock
Operation activate/stop	RUN	RW	00000 : Stop *5 00001 : Activate
Operation mode select	RST	RW	00000 : Fixed Temp operation *5 00002 : Program operation
Step No. monitor	_ST	R	00000 : Program stop *2 00001~00030 : Step 1~30
Operation step remaining time monitor	_TI	R	00000 : Time-up *2 00001~99950 : 000 hour 01 min~999 hour 50 min
Output monitor	OM1	R	00000 : 1 st digit=Heater output 2 nd digit=Door input status output 3 rd digit=Main output 4 th digit=Time-up output or alarm output 5 th digit=Overheat prevention 2 output ※ Output status 0=output OFF 1=output ON
Error monitor 1	ER1	R	00000 : 1 st digit=Memory error 2 nd digit=Sensor error 3 rd digit=AT error 4 th digit=Heater disconnection error 5 th digit=SSR short-circuit error ※ Error status 0=No error 1=Error
Error monitor 2	ER2	R	00000 : 1 st digit=Door open 2 nd digit=Overheat prevention 1 error 3 rd digit=Overheat prevention 2 error 4 th digit=Internal com/temp input circuit error 5 th digit=Not used ※ Error status 0=No error (door closed) 1=Error (door open)
Measured temp monitor	PV1	R	(Ex) 00100=100°C (thermocouple input) 01000=100.0°C (platinum input) HHHHH=Measured temp over scale (common input) LLLLL=Measured temp under scale (common input) ※ The resolution of measured temp of the platinum input is as 10 times higher as that of thermocouple input.

4. Operating procedures

Option (RS485 communication function)

8. ASCII code list

ASCII code	02H	03H	06H	15H						
Symbols used	STX	ETX	ACK	NAK						

ASCII code	30H	31H	32H	33H	34H	35H	36H	37H	38H	39H
Figures used	0	1	2	3	4	5	6	7	8	9

ASCII code	2DH	20H								
Figures used	– Minus	SP Space								

ASCII code	41H	42H	43H	44H	45H	46H	47H	48H	49H	4AH
Char. used	A	B	C	D	E	F	G	H	I	J

ASCII code	4BH	4CH	4DH	4EH	4FH	50H	51H	52H	53H	54H
Char. used	K	L	M	N	O	P	Q	R	S	T

ASCII code	55H	56H	57H	58H	59H	5AH	20H			
Char. used	U	V	W	X	Y	Z	SP Space			

5. Handling Precautions



WARNING

1. About unusable materials

-  Never use explosive materials, flammable materials, or materials that contain such materials for this unit. An explosion or a fire may result.
See “13. List of dangerous materials” on P.65.

2. About ban on use/countermeasures when an error occurred

-  If this unit generates smoke or odd odor for unknown reason, immediately turn power of the unit, remove the power cord off the power supply, and ask inspection to your dealer, one of our sales offices, or our general customer service center. Leaving the unit in such condition may cause a fire or an electric shock. Never attempt to repair the unit by yourself, which will cause a danger.



CAUTION

1. Do not put any objects on the unit.

-  Do not put any objects on the unit. They may fall off and cause a personal injury.

2. When thunder is heard.

-  When thunder is heard, immediately turn the power of the unit off and then shut the power supply off. Leaving the unit in such condition may cause a malfunction or a fire by lightning.

3. When opening/closing door.

-  When opening or closing a door, do not put your hands or face close to its moving range (space). The door may hit your hand or face and cause a personal injury.

4. Do not operate the unit with the door open.

-  · While the door of the unit is open, both of the heater and the motor are OFF and you cannot operate the unit. Be sure to close the door before attempting to operate the unit.
· Avoid leaving the unit with its door open after operation in order, for example, to cool specimen more quickly. Heat from inside the bath may deform the control panel or cause a malfunction of the control devices.

5. Ban on use of corrosive materials

-  Although inside the bath is made of stainless steel NSSC180, it might corrode with a strong acid. Door packing is made of silicon rubber (V-type is made of Fluoro rubber). Note that it may be corroded with acids, alkaline materials, oils, or halogen based solvents.

6. Use the unit at an appropriate temperature.

-  The operational temperature range is the room temperature +30°C~260°C.
Never use the unit at a temperature outside the operational temperature range.

5. Handling Precautions



7. Exhaust port.

- ⊘ At first, some odd odor may be felt while the unit is being used. Assure sufficient ventilation in the room.
Some heat will leak at the exhaust port even when the unit is operated with the manual damper closed. When using the unit, be sure to connect a duct for the exhaust port to allow discharging outside.
See "16. About handling of the exhaust port (manual damper)" on P.8.

8. Installing specimens.

- ⊘ The withstand weight of the included shelf boards is about 15kg. Do not put any specimens heavier than this. Also, when adding shelf boards, take care not to exceed the total weight of specimen below.
《Total weight of specimens when shelf boards are installed at all stages》
DKG610(V),DKG650(V) : 45Kg or less
DKG810(V),DKG850(V) : 75Kg or less
When multiple specimens are placed, place them as dispersed as possible.
Placing too many specimens may prevent proper temperature control. To assure temperature control precision, put specimens taking care so that at least 30% or more space are assured on shelf boards.

9. Do not place any specimens on the bottom of inside the bath.

- ! Using the unit with specimens placed directly on the bottom inside the bath may prevent the unit from exercising its highest performance as well as in-bath temperature may rise excessively or a malfunction may be caused. Never place any specimens on the bottom surface.
Place specimens on included shelf boards and put the shelf boards on the shelf pegs.

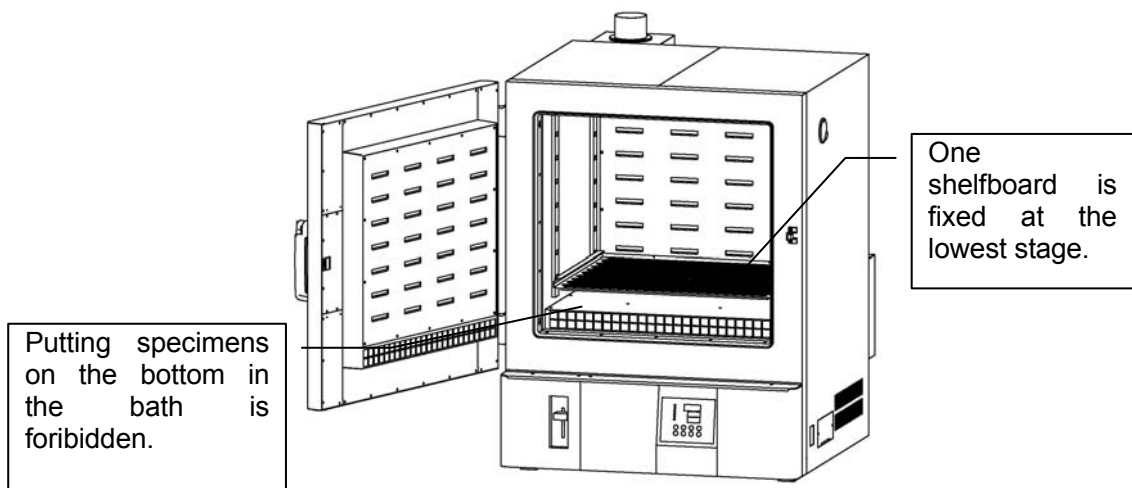

10. About recovery from a power outage.

- ! When a power outage occurs during operation and then power is supplied, the unit resumes operation at the status immediately before the outage.

11. After installation.

- ! The unit may topple down from an earthquake or unexpected shocks and cause a personal injury.
Implement proper tip-preventive measures for safety.

6. Maintenance procedures

Daily inspection/maintenance

Warning

- Be sure to pull out the power cord from the power source unless necessary before trying to do inspection and maintenance works.
- Start these works after the device has returned to the normal temperature.
- Never try to disassemble the unit.

Caution

- Wipe off any dirt with a tightly wrung soft cloth. Never try to clean the unit with benzene, thinner or scouring powder, or rub with a scrubbing brush. Deformation, degradation or discoloration may result.

Every month

- Inspect the functions of the ELB.
 - Test shall be performed with the power cord connected and power is being supplied to the unit.
 - First turn the ELB to “ON(I)”.
 - Then, press the test button on the device with a ball-point pen to check whether it is turned off to indicate that it is in the normal state.

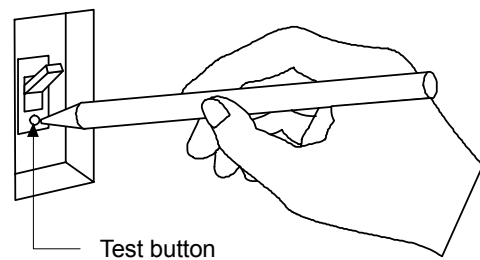

7. When the unit is not to be used for a long time or when disposing

When the unit is not to be used for a long time or when disposing



Caution

When the unit is not going to be used for a long time

- Turn the main unit power off and remove the power cord off the power supply.



Warning

When disposing the unit

- Do not leave the unit where children may play around.
- Remove the handle to prevent the door from locking before discarding the unit.
- In general, dispose the unit as a bulky waste.

Notes about disposition

Always pay attention to the preservation of the global environment.

- We highly recommend taking the unit apart as far as possible for separation or recycling to contribute to the preservation of the global environment. Major components and materials for the unit are as follows:

Names of major parts	Major materials
Major components of the main unit	
Outer finish	Steel sheet, melamine resin baking finish
Internal bath	Stainless steel
Heat insulator	Glass wool
Door packing	Silicone rubber (Fluororubber for model V)
Handle	Aluminum die-cast, epoxy melamine resin baking finish
Nameplate	Polyethylene (PET) resin film
Major electric parts	
Heater	SUS321 stainless steel pipe heater
Motor	Composite part of steel plates, copper wires, and resin sheathed wires.
Substrates	Substrate : Epoxy resin, glass fiber Condensers, resistors, and transformers are installed on a substrate.
Power cord and other wiring materials, others	Synthesized rubber sheath and resin sheathed wires.

8. Troubleshooting







Safety device and error codes

The unit has the self diagnostic function with a controller and a separate safety device.

Table below shows possible causes and measures when the safety device is triggered.

[Error codes]

When an operational error or a malfunction should occur, the alarm lamp on the control panel comes on, an error code is displayed, and the alarm buzzer sounds. When an error occurs, check the error code and immediately stop operating the unit. Note that a measured temperature error will be notified only with indication and the alarm lamp will not sound and the alarm lamp will not sound.

Safety device	Symptom	Possible causes and measures
Detection of sensor error	Alarm lamp on  indication	<ul style="list-style-type: none"> ● Disconnection or other errors in the temperature sensor Contact our service department.
Detection of SSR short circuit	Alarm lamp on  indication	<ul style="list-style-type: none"> ● SSR short circuit Contact our service department.
Detection of heater disconnection	Alarm lamp on  indication	<ul style="list-style-type: none"> ● Heater disconnection ● Current detecting element disconnection or error ● Temperature fuse blown out Contact our service department.
Memory error	Alarm lamp on  indication	<ul style="list-style-type: none"> ● Memory setting error Contact our service department.
Internal communication error	Alarm lamp on  indication	<ul style="list-style-type: none"> ● Internal communication error, temp. input circuit error Contact our service department.
Overheat	Alarm lamp on  indication	<ul style="list-style-type: none"> ● Activation of overheat preventive unit ● Overheat preventive unit disconnection or error Check the set temperature. If the unit does not reset, contact our service department.
Measured temperature error	----- indication	Measured temperature is out of display range Contact our service department.

8. Troubleshooting

When a malfunction is suspected

If any of the symptoms below occurs

Symptom	Check
Turning the power on will not activate the unit.	<ul style="list-style-type: none"> ● If the power cord is connected to the power supply or socket securely. ● If power outage is occurring..
Temperature does not rise.	<ul style="list-style-type: none"> ● If the set temperature is below that in the bath. ● If the power supply voltage has declined. ● If the ambient temperature is outside the usable environmental temperature range. Usable environmental temperature range is 5°C~35°C. ● If the cooling load in the bath is too large. ● If the manual damper is opened. ● If an exhaust fan with a air amount exceeding the specification is not used when connecting the exhaust duct. Check the procedures for connecting the exhaust duct in “16. About handling of the exhaust port (manual damper)” on P.8.
Temperature fluctuates during operation.	<ul style="list-style-type: none"> ● If the set temperature is appropriate. ● If the power supply voltage has declined. ● IF fluctuation of the environmental temperature has become large. ● If load for inside the bath is large.
Displayed temperature is different from the measured temperature.	<ul style="list-style-type: none"> ● If the calibration offset setting is other than “0”. Set it to “0”. Check the setting in “Using the Calibration Offset function” on P.34.

- ◆ If the symptom does not match any of the above, immediately turn the power switch on the main unit off, pull out the power cord from the power supply and contact your dealer or one of our sales offices or our support center.

9. After sales service and warranty

When requesting a repair

When requesting a repair

If any trouble occurs, immediately stop operation, turn the power switch off, pull out the power plug and contact your dealer or our sales office.

Information necessary for requesting a repair

- Model name of the product
 - Serial number
 - Date (y/m/d) of purchase
 - Description of trouble (as in detail as possible)
- } See the warranty card or the nameplate on the unit.
See the section "3. Names and Functions of Parts" on page 10.

Be sure to indicate the warranty card to our service representative.

Warranty card (attached separately)

- Warranty card is given by your dealer or one of our sales offices and please fill in your dealer, date of purchase and other information and fax it to our customer center (03-3231-6523), then store it securely.
- Warranty period is one full year from the date of purchase. Repair service for free is available according to the conditions written on the warranty card.
- For repairs after the warranty period consult your dealer or one of our sales offices. Paid repair service is available on your request when the product's functionality can be maintained by repair.

Minimum holding period of repair parts

The minimum holding period of repair parts for this product is seven years after end of production.

Repair parts here refer to parts necessary for maintaining performance of the product.

10. Specifications

Model		DKG610 (V)	DKG650(V)	DKG810 (V)	DKG850(V)
System		Forced blow circulation (with air supply/exhaust damper)			
Operational environmental temperature range		5°C~35°C			
※1	Operational temperature range	Room temperature +30°C~260°C			
	Temperature adjustment precision	±0.5°C (exhaust port fully closed)			
	Temperature distribution precision	±2.0°C(at200°C, exhaust port fully closed), ±2.5°C(at260°C, exhaust port fully closed)			
	Temperature rise time	Within 45 min(25°C→260°C)		Within 50 min(25°C→260°C)	
	Temperature fall time	Approx. 30 min (260°C→50°C)		Approx.40 min (260°C→50°C)	
Mechanism	Exterior finish	Chrome-free electro galvanized chemical proof bake finished steel plate			
	Heat insulator	Glass wool			
	Heater	SUS pipe heater			
	Heater capacity ※2	2.6~3.16kW	2.6~2.84kW	3.6~4.36kW	3.6~3.92kW
	Blower fan motor	Sirocco fan x 1 Condenser motor 30W		X 2 30W x 2	
	Exhaust port flange	80 mm Top rear of the unit			
	Door packing	Silicon rubber (V type is Fluoro rubber)			
	Exhaust damper	Air supply/exhaust linked manual damper			
Control assembly	Controller	Model VS4PG Program controller			
	Control system	PID control of heater output with a PC			
	Setting system	Digital setting system with dedicated menu keys and ▼▲ keys			
	Display system	Measured temp display : 4-digit green LED digital display			
		Set temp display : 4-digit red LED digital display			
	Timer	1 min-99 hrs 59 min and 100 hrs -999.5 hrs (with Timer Wait function)			
	Timer resolution	1 min or 10 min			
	Operation function	Fixed Temp operation, Program operation, Quick Auto Stop operation, Auto Stop operation, Auto Start operation			
	Program mode	Program operation :3 patterns 30 steps, Pattern Repeat function			
	Sensor	K-thermocouple both for control sensor and overheat preventive sensor			
Additional functions	Calibration Offset function, Lock function, Power Outage Compensation function				
Safety unit	Self diagnostic functions	Temp sensor error, heater error, memory error, SSR short-circuit, automatic overheat prevention error, measured temp error, door switch			
	Protection device	ELB with overcurrent protector, overheat preventive device(electronic system integrated with the controller), temp fuse			
Standards	External dimensions (mm) ※3 (W x D x H)	770 x 696(846) x 985 Figure in () includes the exhaust ducts		770 x 696(846) x 1674 Figure in () includes the exhaust ducts	
	Internal dimensions (mm) ※3 (W x D x H)	600 x 500 x 500		600 x 500 x 1000	
	Internal capacity	150ℓ		300ℓ	
	Withstand weight of shelf board	15 kg/unit			
	Number of stages	7 stages		15 stages	
	Shelf peg pitch	60 mm			

10. Specifications

Model		DKG610 (V)	DKG650(V)	DKG810 (V)	DKG850(V)
Standards	Power supply (50/60Hz)	1ΦAC200~ 220V 13.3A~14.6A	1ΦAC230~ 240V 11.6A~12.1A	1ΦAC200~ 220V 18.5A~20.3A	1 Φ AC200 ~ 220V 16.2A~16.8A
	Weight	Approx. 110kg		Approx. 155kg	
Accessories	Shelf boards	Punched stainless steel			
		2		4	
	Shelf pegs	4		8	
		Operation manual, warranty card			

- ※1 Performance data has been measured at room temperature of $23^{\circ}\text{C} \pm 5^{\circ}\text{C}$, humidity of 65% RH $\pm 5\%$, and no-load with the power supply of AC200V (AC230V for DKG650(V)/DKG850(V)). Temperature rise time is for when the exhaust port is closed while the temperature fall time is for when the exhaust port is opened.
- ※2 Heater capacity is for the converted voltage.
- ※3 Do not include protrusions.

11. Wiring diagram

DKG610(V)

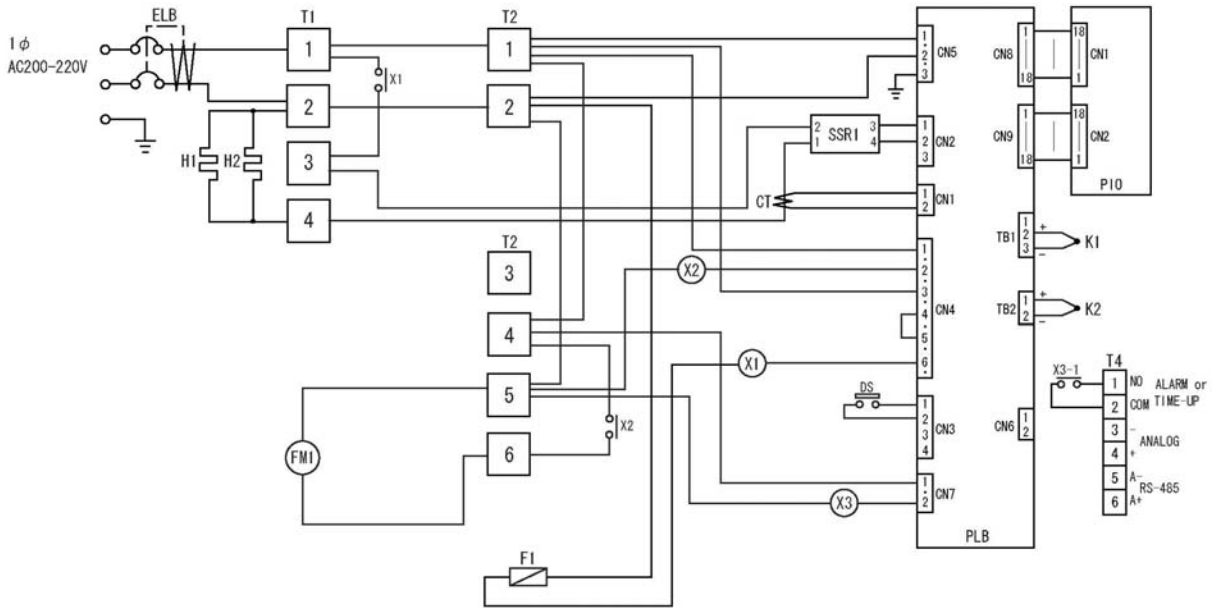

DKG650(V)

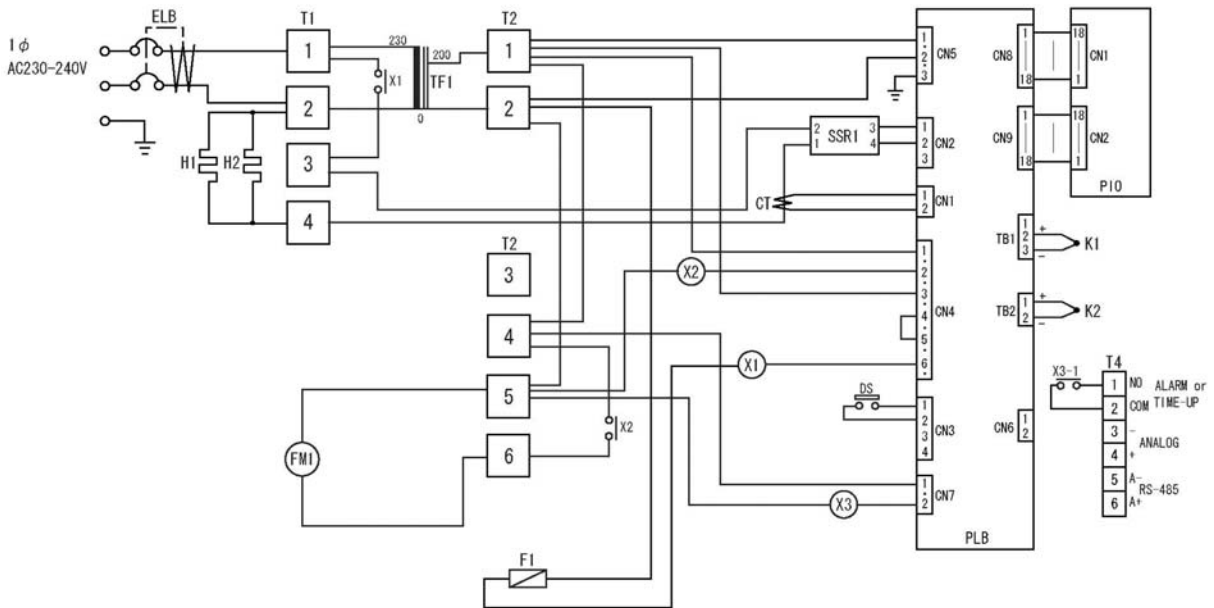

Symbol	Part name	Symbol	Part name
ELB	Electric Leakage Breaker	PLB	VS4PG controller
T1,T2,T4	Terminal block	PIO	Display substrate
H1,H2	Heater	K1	Control sensor
X1~X3	Relay	K2	Overheat preventive sensor
FM1	Circulation fan motor	CT	Current sensor
SSR1	No-contact relay	F1	Temperature fuse
DS	Door switch	TF1	Transformer

11. Wiring diagram

• DKG810(V)

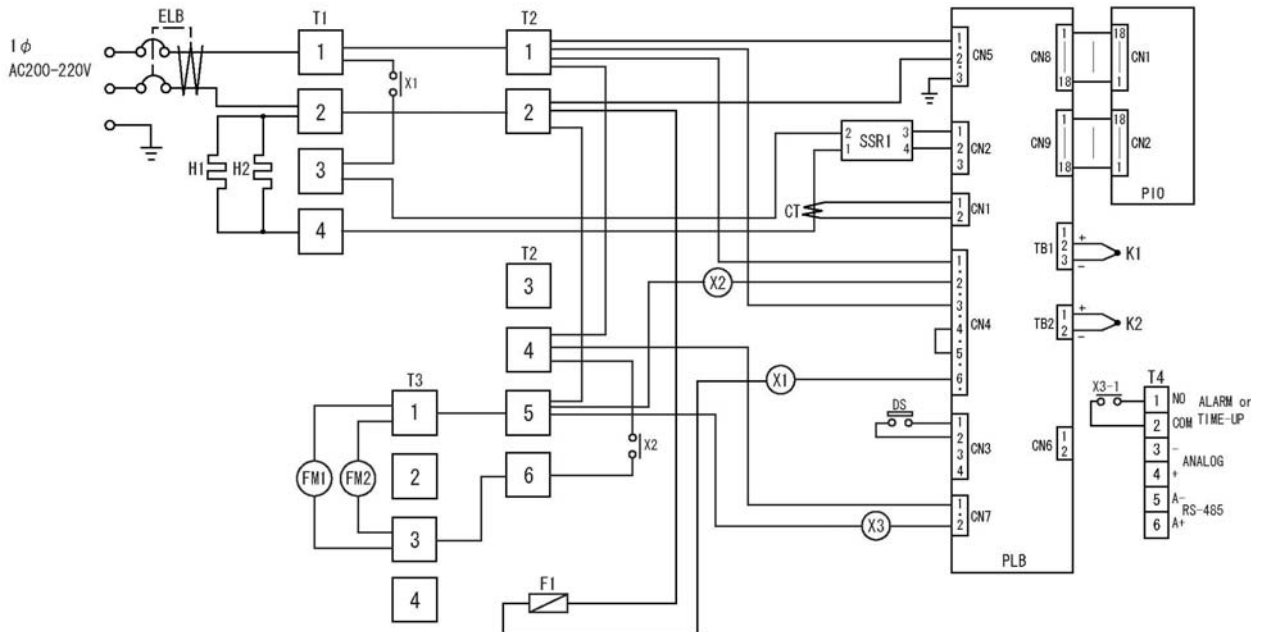

• DKG850(V)

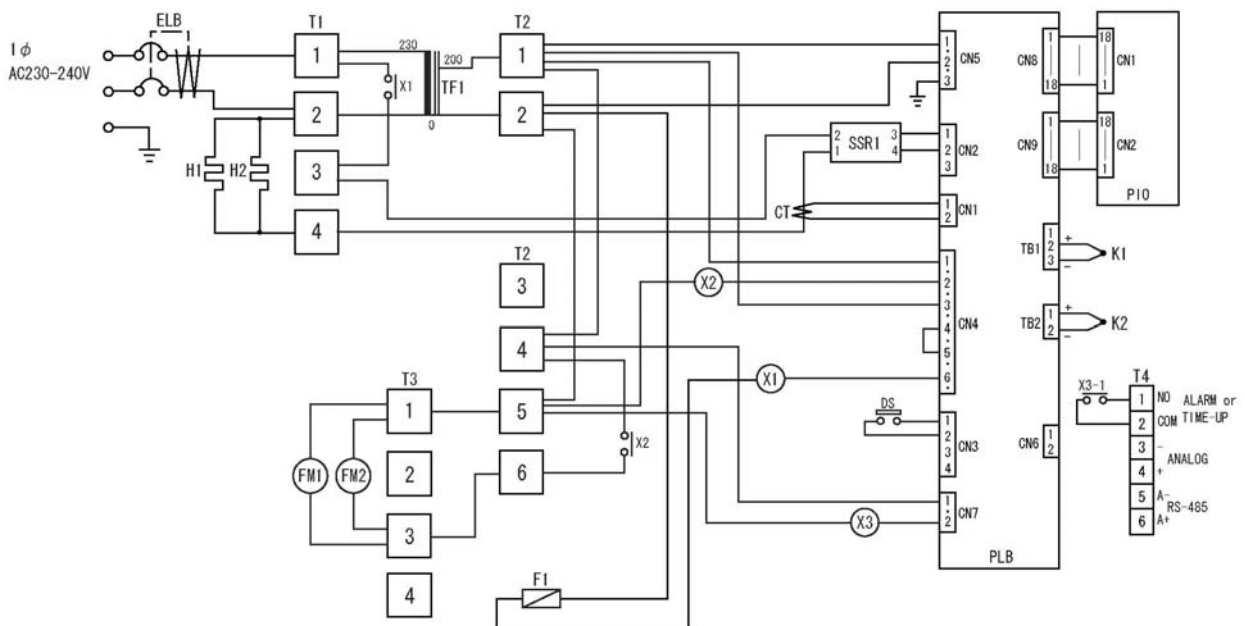

Symbol	Part name	Symbol	Part name
ELB	Electric Leakage Breaker	PLB	VS4PG controller
T1~T4	Terminal block	PIO	Display substrate
H1, H2	Heater	K1	Control sensor
X1~X3	Relay	K2	Overheat preventive sensor
FM1,FM2	Circulation fan motor	CT	Current sensor
SSR1	No-contact relay	F1	Temperature fuse
DS	Door switch	TF1	Transformer

12. Replacement parts list

Common parts

Symbol	Part name	Specifications	Manufacturer	Code No.
K1	Sensor	K-thermocouple	Nihondensoku	1160030049
FM1	Motor	IC-8434 YAMB 200V/30W CCW	Seishin	2140000036
F1	Thermal fuse	200V 10A 167°C	Uchihashi Estec	LT00031818
T1	Terminal block	ATK-20-4P	TOYOGIKEN	LT00004736
T2	Terminal block	MO11-0FX 6P	TOYOGIKEN	2070230009
PLB	VS4PG controller	VS4PG	Yamato	LT00029542
	Tough card	15P 300mm	Toho	1130000008
PIO	Display substrate	For VS3,4	Yamato	1020000051
SSR1	SSR	TRS1245	Toho	2160000036
CT	Current detection element	CTL-6-S-H	U_RD	2170010005
DS	Lead relay	LAB1(recreation)	Omron	LT00035254
X1	Relay	AHE1275	Panasonic	2050000059
X2	Relay	G2R-1A-T AC200V	Omron	2050000037
T4	Terminal block	MF10-4AX 6P with a cover	TOYOGIKEN	LT00009399
X3	Relay	AP3125F	Panasonic	LT00022099
X3	Socket	AP3822K	Panasonic	2050081004
	Door packing ※	DNE65-40791 Silicon	Yamato	LT00033164
	Door packing ※	DNE65V-40001 Viton	Yamato	LT00033165
	Handle box	DNE60—40080	Yamato	DNE6040080
	Axis	DNE60-40290	Yamato	DNE6040290
	Hook (A)	DN93S-40000	Yamato	DN931
	Hook (B)	DN93S-40010	Yamato	DN932
	Spring	DNE60-40710	Yamato	DNE6040710
	Handle	DTS82-30820	Yamato	DTS8230820
	Push	DTS82-30830	Yamato	DTS8230830
	Stopper	DTS82-42030	Yamato	DTS8242030
	Push pin	DTS82-42040	Yamato	DTS8242040

* The length is 2.5m for 600 class and 3.5m for 800 class. For those models whose model number ends with V are of Fluoro rubber specification.

DKG610(V) replacement parts

Symbol	Part name	Specifications	Manufacturer	Code No.
H1	Lower heater	DKG61-30120	Yamato	LT00030137
H2	Upper heater	DKG61-30130	Yamato	LT00030138
K2	Sensor	08L-0128-NT	Nihondensoku	LT00030145
	Power cord	T3-3d 3m	Yamato	2130010010
ELB	Electric leakage breaker	BJS2032S	Panasonic	LT00029544
	Sirocco fan	S2-178053L-8G CCW	Rokugo	DK812

12. Replacement parts list

DKG650(V) replacement parts

Symbol	Part name	Specifications	Manufacturer	Code No.
H1	Lower heater	DKG65-30020	Yamato	LT00030139
H2	Upper heater	DKG65-30030	Yamato	LT00030140
K2	Sensor	08L-0128-NT	Nihondensoku	LT00030145
	Power cord	T3-3d 3m	Yamato	2130010010
ELB	Electric leakage breaker	BJS1532S	Panasonic	LT00029543
TF1	Transformer	UD22-200A2	Toyoden	BB519
	Sirocco fan	S2-178053L-8G CCW	Rokugo	DK812

DKG810(V) replacement parts

Symbol	Part name	Specifications	Manufacturer	Code No.
FM2	Motor	IC-8434 YAMB-1 200V30WCW	Seishin	2140000048
H1	Lower heater	DKG81-30050	Yamato	LT00030141
H2	Upper heater	DKG81-30060	Yamato	LT00030142
K2	Sensor	08L-0130-NT	Nihondensoku	LT00030147
	Power cord	T3-3e 4.5m	Yamato	2130056006
ELB	Electric leakage breaker	BJS3032S	Panasonic	LT00029545
T3	Terminal block	MO11-0FX 4P	TOYOGIKEN	2070230001
	Sirocco fan	S2-158053L-8G CCW	Rokugo	DN002
	Sirocco fan	S2-158053R-8G CW	Rokugo	DN169

DKG850(V) replacement parts

Symbol	Part name	Specifications	Manufacturer	Code No.
FM2	Motor	IC-8434 YAMB-1 200V30WCW	Seishin	2140000048
H1	Lower heater	DKG85-30020	Yamato	LT00030143
H2	Upper heater	DKG85-30030	Yamato	LT00030144
K2	Sensor	08L-0130-NT	Nihondensoku	LT00030147
	Power cord	T3-3e 4.5m	Yamato	2130056006
ELB	Electric leakage breaker	NV-L22GR 30A	Mitsubishi	LT00029777
TF1	Transformer	UD22-200A2	Toyoden	BB519
T3	Terminal block	MO11-0FX 4P	TOYOGIKEN	2070230001
	Sirocco fan	S2-158053L-8G CCW	Rokugo	DN002
	Sirocco fan	S2-158053R-8G CW	Rokugo	DN169

* Employed components are subject to change without prior notice.

13. List of dangerous materials



Never use an explosive substance a flammable substance or a substance containing them for this device.

Explosive substance	Explosive substance	① Nitroglycol, glycerine trinitrate, cellulose nitrate and other explosive nitrate esters
		② Trinitrobenzen, trinitrotoluene, picric acid and other explosive nitro compounds
		③ Acetyl hydroperoxide, methyl ethyl ketone peroxide, benzoyl peroxide and other organic peroxides
Flammable substances	Explosive substances	Metal "lithium", metal "potassium", metal "natrium", yellow phosphorus, phosphorus sulfide, red phosphorus, celluloids, calcium carbide (a.k.a, carbide), lime phosphide, magnesium powder, aluminum powder, metal powder other than magnesium and aluminum powder, sodium dithionous acid (a.k.a., hydrosulphite)
	Oxidizing substances	① Potassium chlorate, sodium chlorate, ammonium chlorate, and other chlorates
		② Potassium perchlorate, sodium perchlorate, ammonium perchlorate, and other perchlorates
		③ Potassium peroxide, sodium peroxide, barium peroxide, and other inorganic peroxides
		④ Potassium nitrate, sodium nitrate, ammonium nitrate, and other nitrates
		⑤ Sodium chlorite and other chlorites
		⑥ Calcium hypochlorite and other hypochlorites
	Flammable substances	① Ethyl ether, gasoline, acetaldehyde, propylene chloride, carbon disulfide, and other substances with ignition point at a degree 30 or more degrees below zero.
		② n-hexane, ethylene oxide, acetone, benzene, methyl ethyl ketone and other substances with ignition point between 30 degrees below zero and less than zero.
		③ Methanol, ethanol, xylene, pentyl acetate, (a.k.a.amyl acetate) and other substances with ignition point between zero and less than 30 degrees.
		④ Kerosene, light oil, terebinth oil, isopenthyl alcohol(a.k.a. isoamyl alcohol), acetic acid and other substances with ignition point between 30 degrees and less than 65 degrees.
	Combustible gas	Hydrogen, acetylene, ethylene, methane, ethane, propane, butane and other gases combustible at 15°C at one air pressure.

(Quoted from the separate table 1 in Article 6, the enforcement order of the Industrial Safety and Health Law)

14. Standard installation manual

* Install the product according to the following: (Confirm separately for optional items or special specifications)

Model	Serial number	Date	Installation mgr.(company name)	Installation mgr.	Judgment

No.	Item	Implementation method	TOC No. Reference page of the operating instruction manual	Judgment
Specifications				
1	Accessories	Check for number of accessories on the basis of the column for accessories.	10. Specifications field P.59 ~P.60	
2	Installation	<ul style="list-style-type: none"> Visual check of environmental conditions Caution: Take care for environment	2. Before operating the unit <ul style="list-style-type: none"> On the installation site P.4	
		<ul style="list-style-type: none"> Securing a space 		
Operation-related matters				
1	Source voltage	<ul style="list-style-type: none"> Measure the user side voltage (outlet, distribution board, etc.) with a tester Measure voltage during operation (shall meet the specifications) Caution: Always use a plug that meets the specification for attaching to the ELB.	2. Before operating the unit <ul style="list-style-type: none"> Be sure to connect the ground wire. Power supply is 10.Specifications <ul style="list-style-type: none"> Specification - power supply P.6 P.6 P.60~	
2	Operation start (Fixed Temp operation)	<ul style="list-style-type: none"> Perform Fixed Temp operation. Set to 100°C and check the stable status. Note : Check that the calibration offset is set at "0".	4. Operating Procedures <ul style="list-style-type: none"> Fixed Temp operation P. 16~	
3	Operation start (Auto stop)	<ul style="list-style-type: none"> Perform Auto Stop operation. Input 2 minutes to the auto stop mechanism and check for the proper operation. 	4. Operating Procedures <ul style="list-style-type: none"> Auto Stop operation P.16~	
4	Operation start (Auto start)	<ul style="list-style-type: none"> Perform Auto Start operation. Input 2 minutes to the auto start mechanism and check for the proper operation. 	4. Operating Procedures <ul style="list-style-type: none"> Auto Start operation P.16~	
5	Program operation	<ul style="list-style-type: none"> Perform as necessary. 	4. Operating Procedures <ul style="list-style-type: none"> Program operation P.16~	
Description				
1	Operational descriptions	<ul style="list-style-type: none"> Explain the customer about each assembly as per the operation manual. Note : Be sure to explain the Calibration Offset function (to prevent erroneous operation).	4. Operating procedures <ul style="list-style-type: none"> Operating procedures 1. Safety precautions ~ 13. List of dangerous materials P.16~ P.1~ P.65	
2	Error codes	Explain the customer about error codes and procedures for release according to the operational instructions	8. Troubleshooting ~9. After sales service and warranty P.56~58	
3	Maintenance and inspection	Explain operations of each component according to the operational instructions	6. Maintenance procedures <ul style="list-style-type: none"> Daily inspection/maintenance P.54	
4	Completion of installation Entries	<ul style="list-style-type: none"> Fill in the installation date and the installation mgr. on the nameplate of the main unit Fill in necessary information to the warranty card and hand it over to the customer Explanation of the route for after-sales service 	9. After sales service and warranty P.58	

Limited liability

Be sure to use the unit strictly following the handling and operating instructions in this operating instruction.

Yamato Scientific Co., Ltd. assumes no responsibility for an accident or a malfunction caused by use of this product in any way not specified in this operating instruction.

Never attempt to perform matters prohibited in this operation instruction.

Otherwise, an unexpected accident may result.

Notice

- **Descriptions in this operating instruction are subject to change without notice.**
- **We will replace a manual with a missing page or paging disorder.**

Instruction Manual

Rapid Heating / Cooling oven

DKG610(V)/DKG650(V)/DKG810(V)/DKG850(V)

Second edition July, 15, 2009

Revised Feb. 21, 2012

Yamato Scientific Co., Ltd.

〒103-8432

2-1-6, Nihonbashi, Honcho, Chuo-ku,
Tokyo

Customer support center

 Tool free: 0120-405525

<http://www.yamato-net.co.jp>